



Emergency Recovery Information

>> For Audi vehicles May 2015 - Part 1 of 2

Model name	Model cycle	Model name	Model cycle
Audi A1	from 2010	A5 / S5 / RS5	2007 - 2011
Audi A1 / S1 Sportback	from 2012	A5 / S5 Cabriolet	2009 - 2011
		A5 / S5 Sportback	2009 - 2011
Audi A2	2000 - 2005	A5 / S5 / RS5	from 2011
		A5 / S5 Sportback	from 2011
Audi A3 / S3 (3door)	1996 - 2003		
Audi A3 (5door)	1999 - 2003		
A3 / S3 (3-door)	2003 - 2012		
A3 / S3 / RS3 Sportback	2004 - 2012		
A3 Cabriolet	2008 - 2013		
A3 / S3 Sportback	from 2012		
A3 Sportback e-tron	from 2014		
A3 / S3 sedan	from 2013		
A3 / S3 Cabriolet	from 2013		
A4 / S4	1995 - 2001		
A4 / S4 / RS4 Avant	1996 - 2001		
A4 / S4	2001 - 2005		
A4 / S4 Avant	2001 - 2005		
A4 / S4 / RS4	2005 - 2007		
A4 / S4 / RS4 Avant	2005 - 2008		
A4 / S4 Cabriolet	2002 - 2005		
A4 / S4 / RS4 Cabriolet	2005 - 2009		
A4 / S4	2007 - 2012		
A4 / S4 Avant	2008 - 2012		
A4 allroad	2009 - 2012		
A4 / S4	From 2012		
A4 / S4 / RS4 Avant	From 2012		
A4 allroad	From 2012		

Legal Disclaimer:

This manual has been created exclusively for rescuers who have been specially trained in the area of providing emergency rescue after automobile accidents and who are therefore qualified to use the activities described in this manual. Furthermore, this manual shows the maximum possible equipment specification in the model overview.

Vehicle specifications and special options as well as Audi model availability are constantly subject to change. Therefore, Audi reserves the right to change the content of this manual at all times.

Please note: The information contained in this manual is not intended for customers or for repair shops and dealers. Customers may gather detailed information from their vehicle owner's manual regarding vehicle function as well as any occupant safety features and system descriptions. Repair shops and dealers obtain repair information through their normal channels.

(Status: 11/2014)



Hint:

The maximum possible equipment specification is always shown in the model overview.

You will find "Rescue and Recovery involving Audi Vehicles" in a separate part of the same title.

The creation of this Rescue Data sheets is supported by Moditech Rescue Solutions (www.moditech.com). The vehicle overviews in the attachment are also included in interactive form in the data base "Crash Recovery System".

This document is a subject to the copyright of AUDI AG, Ingolstadt. Any duplication, distribution, storage, communication, broadcast and reproduction or transmission of the contents without written approval from AUDI AG is prohibited.



▶ Audi A1 / S1

from 2010

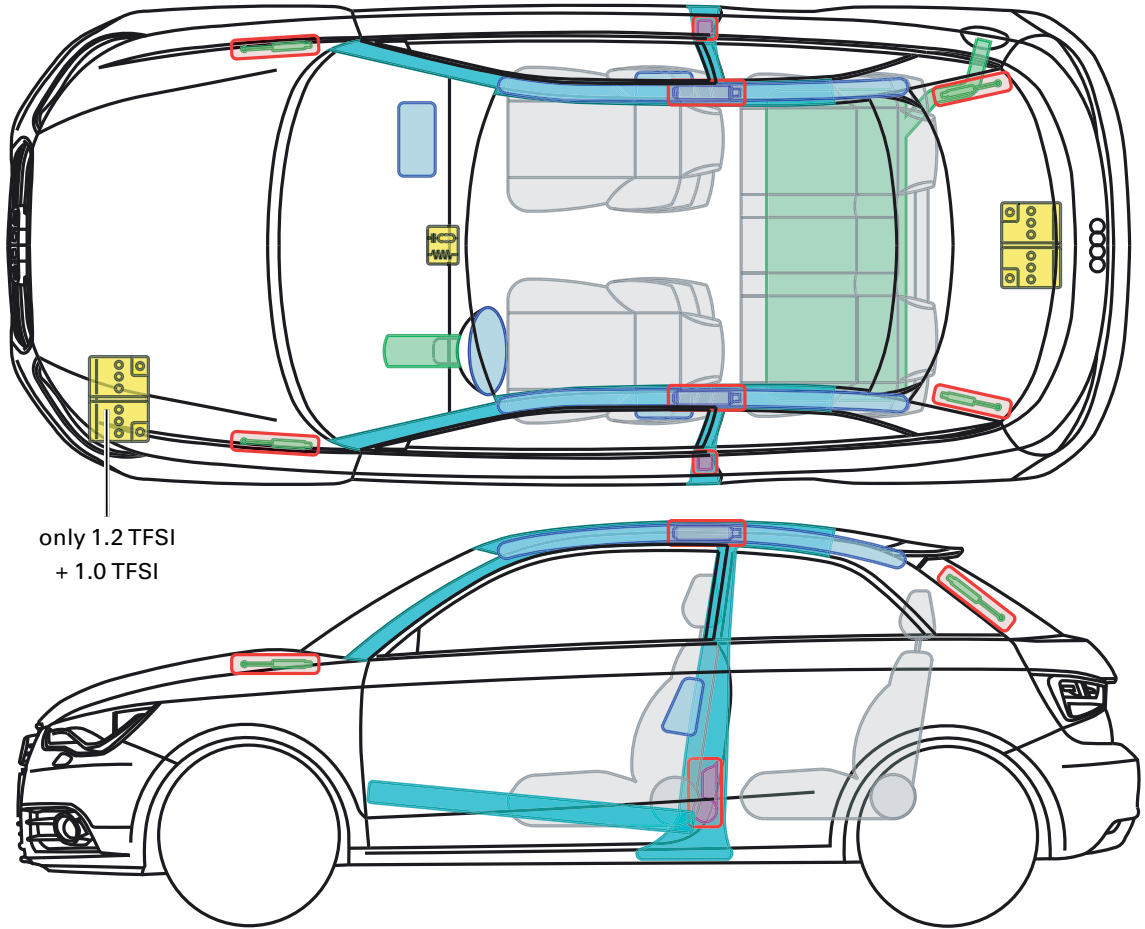

Legend

	Airbag		Reinforce-ment		Control module
	Gas generator		Rollover protection		Battery
	Pre-tensioner		Gas-pressure damper		Fuel tank

This document is a subject to the copyright of AUDI AG, Ingolstadt. Any duplication, distribution, storage, communication, broadcast and reproduction or transmission of the contents without written approval from AUDI AG is prohibited.







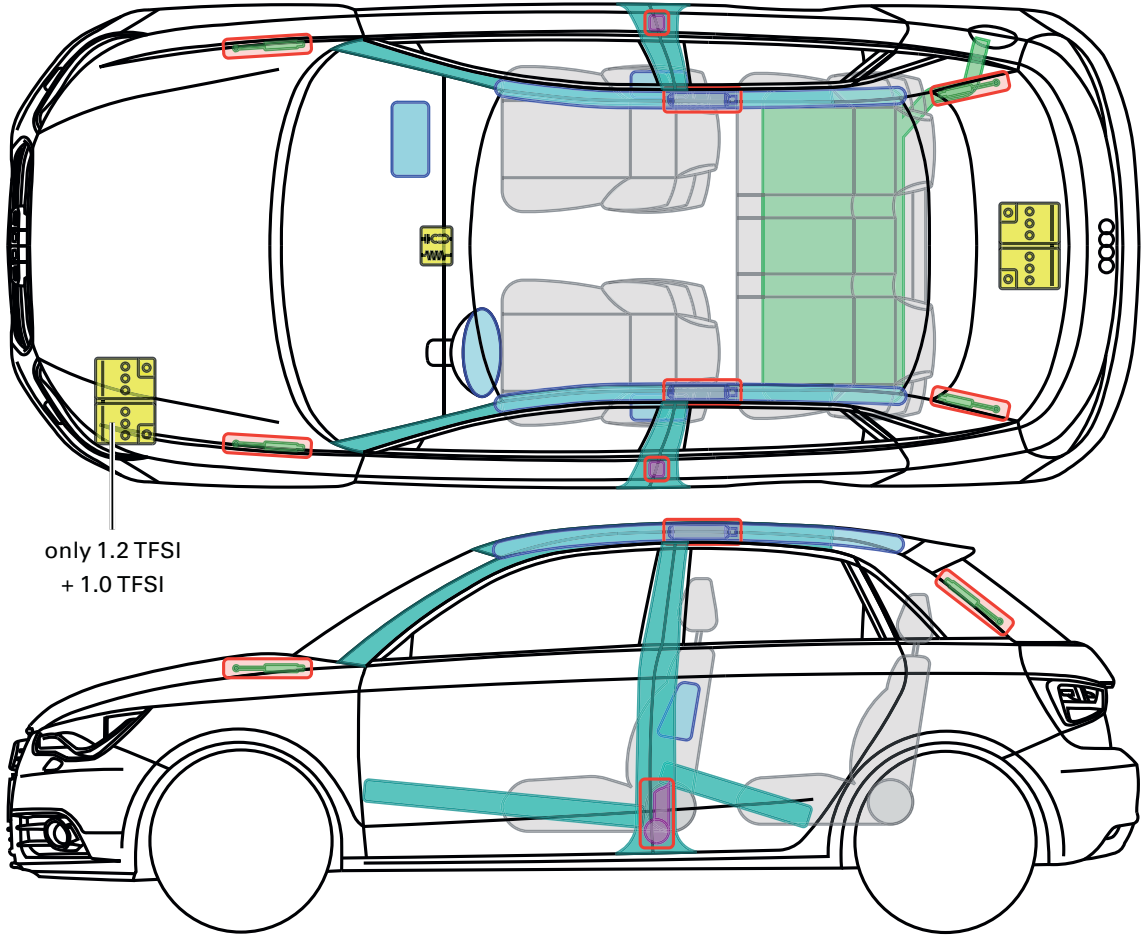

▶ Audi A1 / S1 Sportback

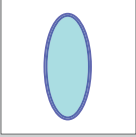
from 2012

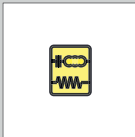
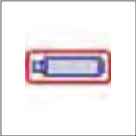

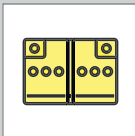
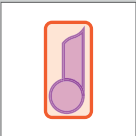
Legend

	Airbag		Reinforcement		Control module
	Gas generator		Rollover protection		Battery
	Pre-tensioner		Gas-pressure damper		Fuel tank

This document is a subject to the copyright of AUDI AG, Ingolstadt. Any duplication, distribution, storage, communication, broadcast and reproduction or transmission of the contents without written approval from AUDI AG is prohibited.





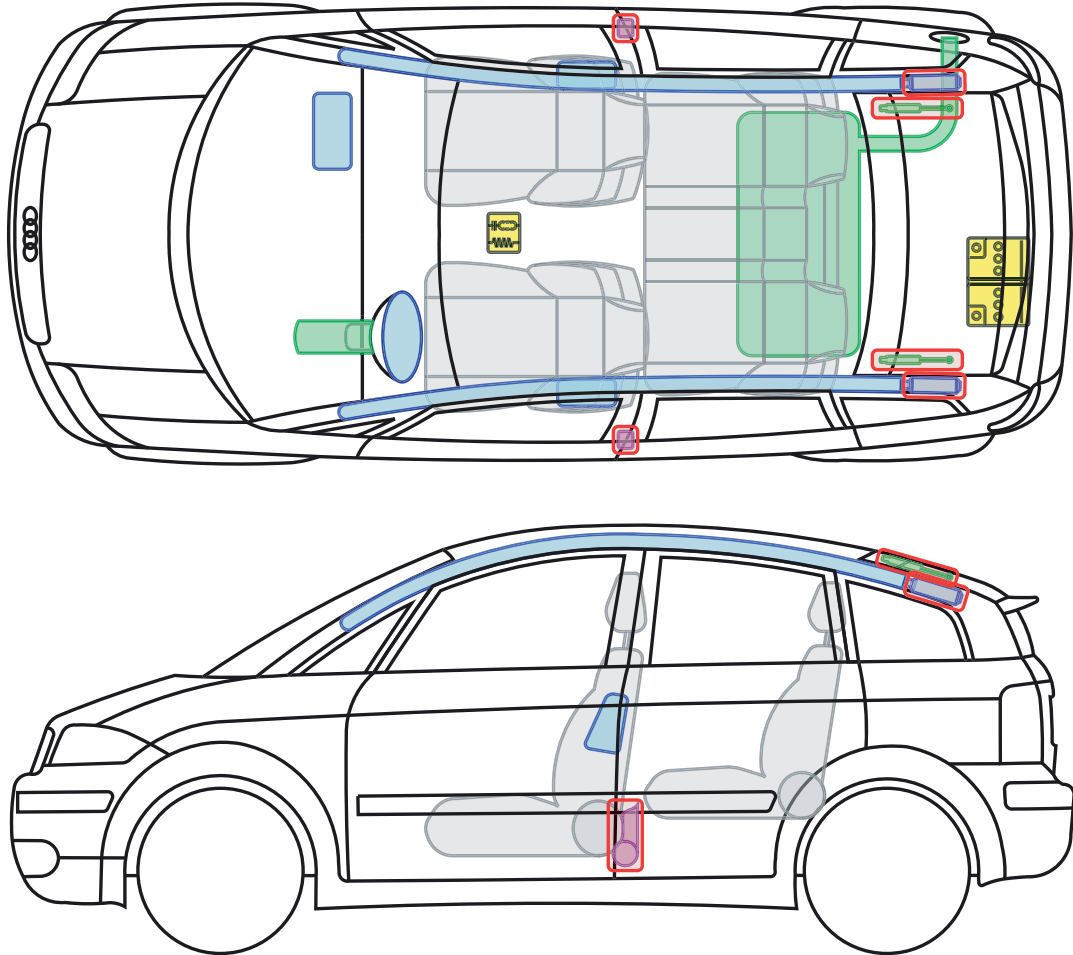

Audi A2

2000 – 2005

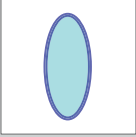
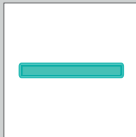
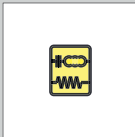
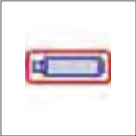

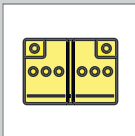
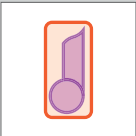
Legend

	Airbag		Reinforcement		Control module
	Gas generator		Rollover protection		Battery
	Pretensioner		Gas-pressure damper		Fuel tank

This document is a subject to the copyright of AUDI AG, Ingolstadt. Any duplication, distribution, storage, communication, broadcast and reproduction or transmission of the contents without written approval from AUDI AG is prohibited.



▶ Audi A3 / S3 (3-door)

1996 – 2003

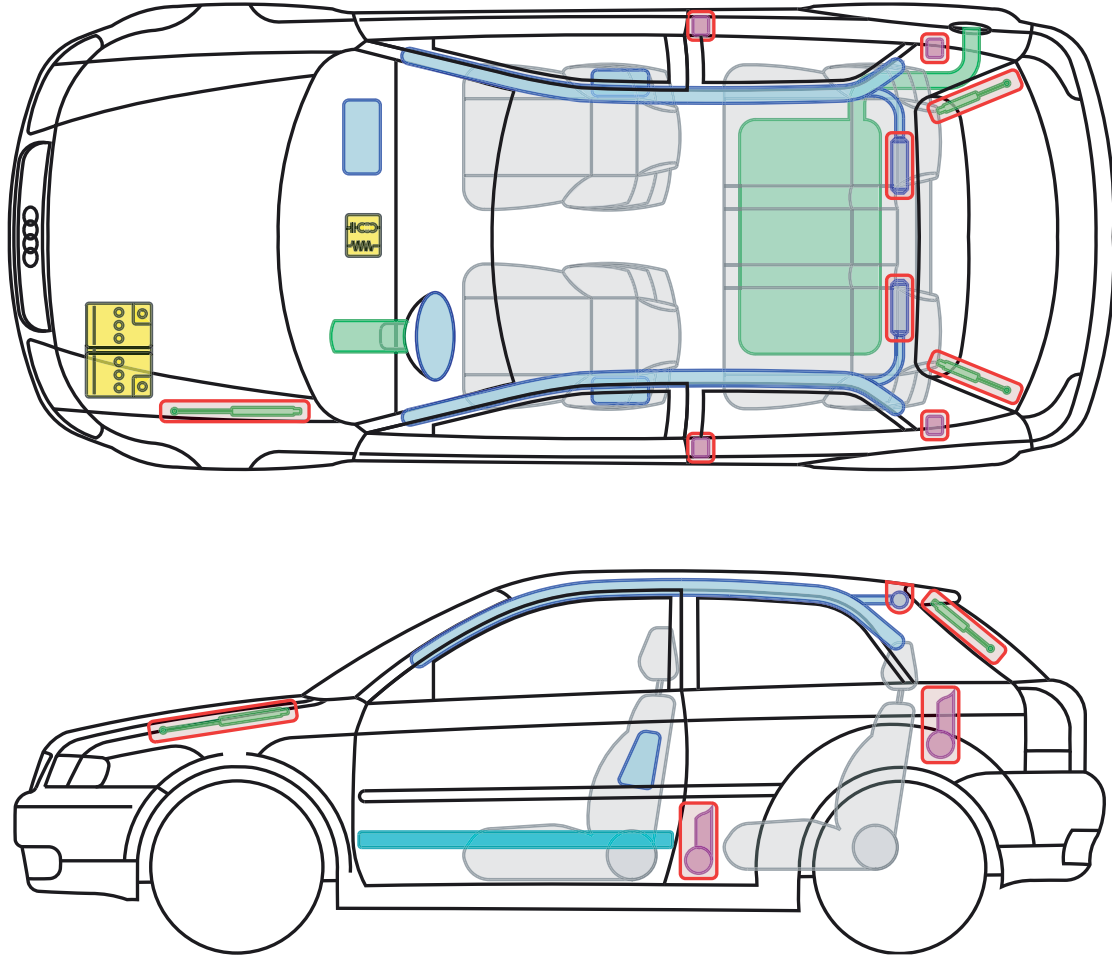

Legend

	Airbag		Reinforce-ment		Control module
	Gas generator		Rollover protection		Battery
	Pre-tensioner		Gas-pressure damper		Fuel tank

This document is a subject to the copyright of AUDI AG, Ingolstadt. Any duplication, distribution, storage, communication, broadcast and reproduction or transmission of the contents without written approval from AUDI AG is prohibited.







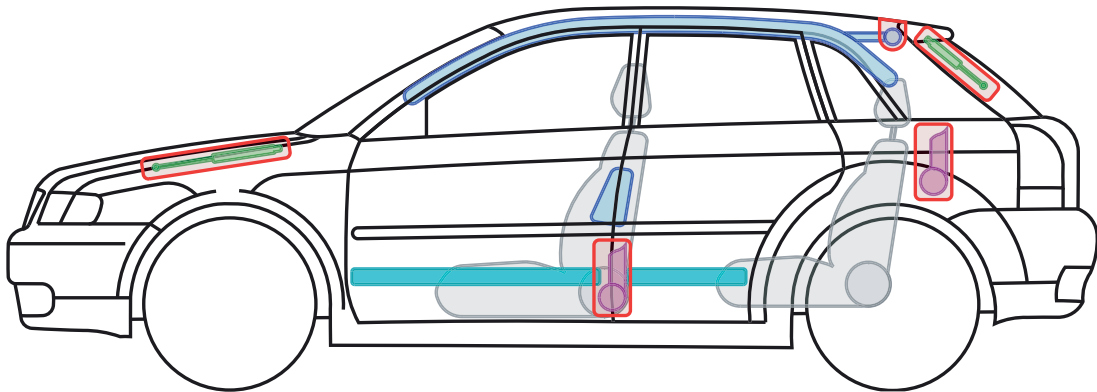
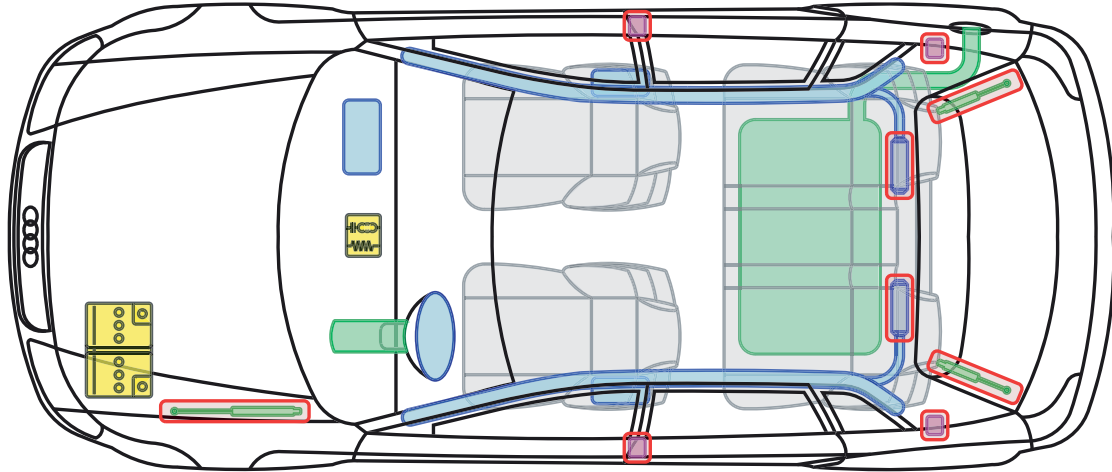

▶ Audi A3 (5-door)

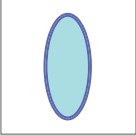
1999 – 2003

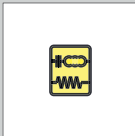
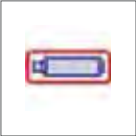

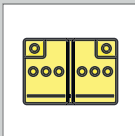
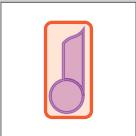
Legend

	Airbag		Reinforce-ment		Control module
	Gas generator		Rollover protection		Battery
	Pre-tensioner		Gas-pressure damper		Fuel tank

This document is a subject to the copyright of AUDI AG, Ingolstadt. Any duplication, distribution, storage, communication, broadcast and reproduction or transmission of the contents without written approval from AUDI AG is prohibited.



▶ Audi A3 / S3 (3-door)

2003 – 2012

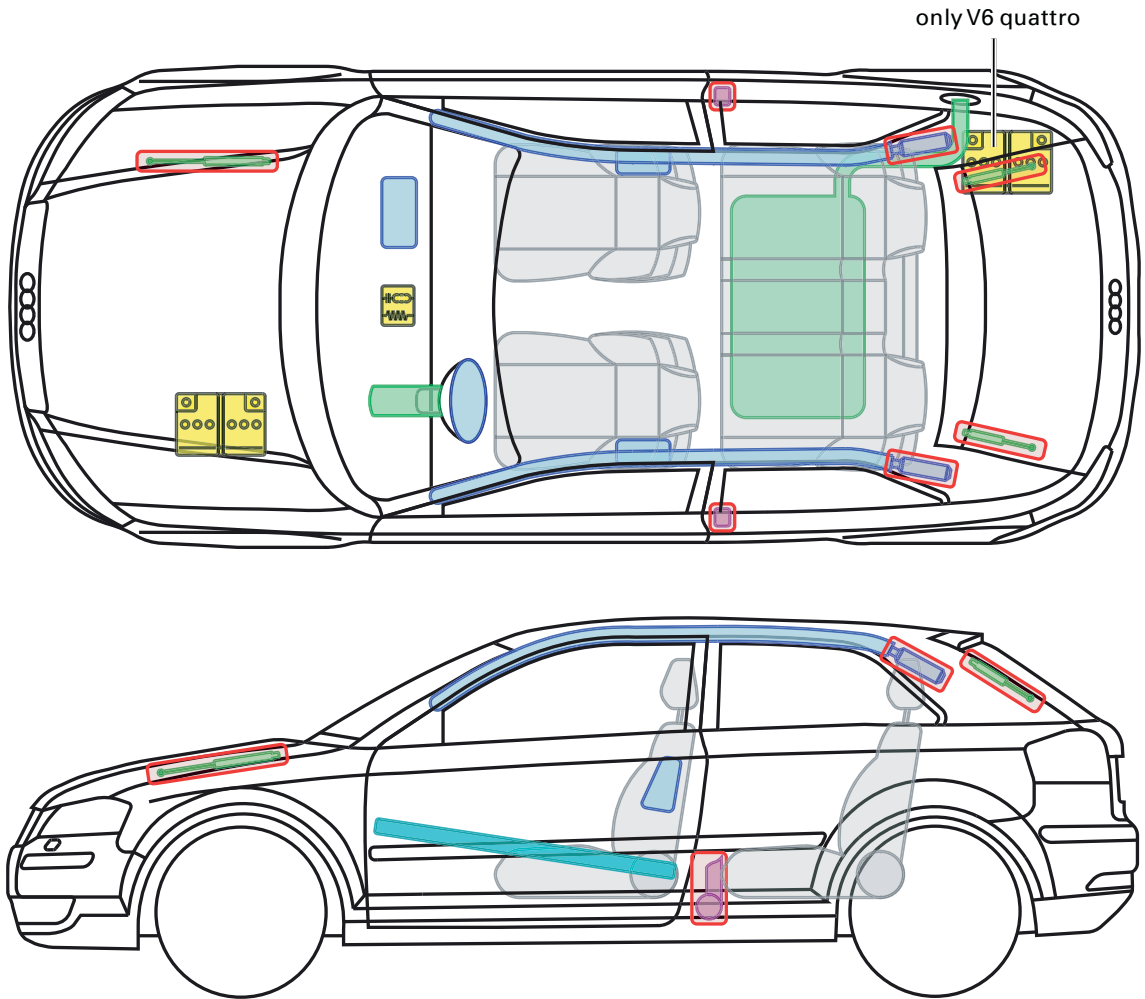

Legend

	Airbag		Reinforcement		Control module
	Gas generator		Rollover protection		Battery
	Pretensioner		Gas-pressure damper		Fuel tank

This document is a subject to the copyright of AUDI AG, Ingolstadt. Any duplication, distribution, storage, communication, broadcast and reproduction or transmission of the contents without written approval from AUDI AG is prohibited.





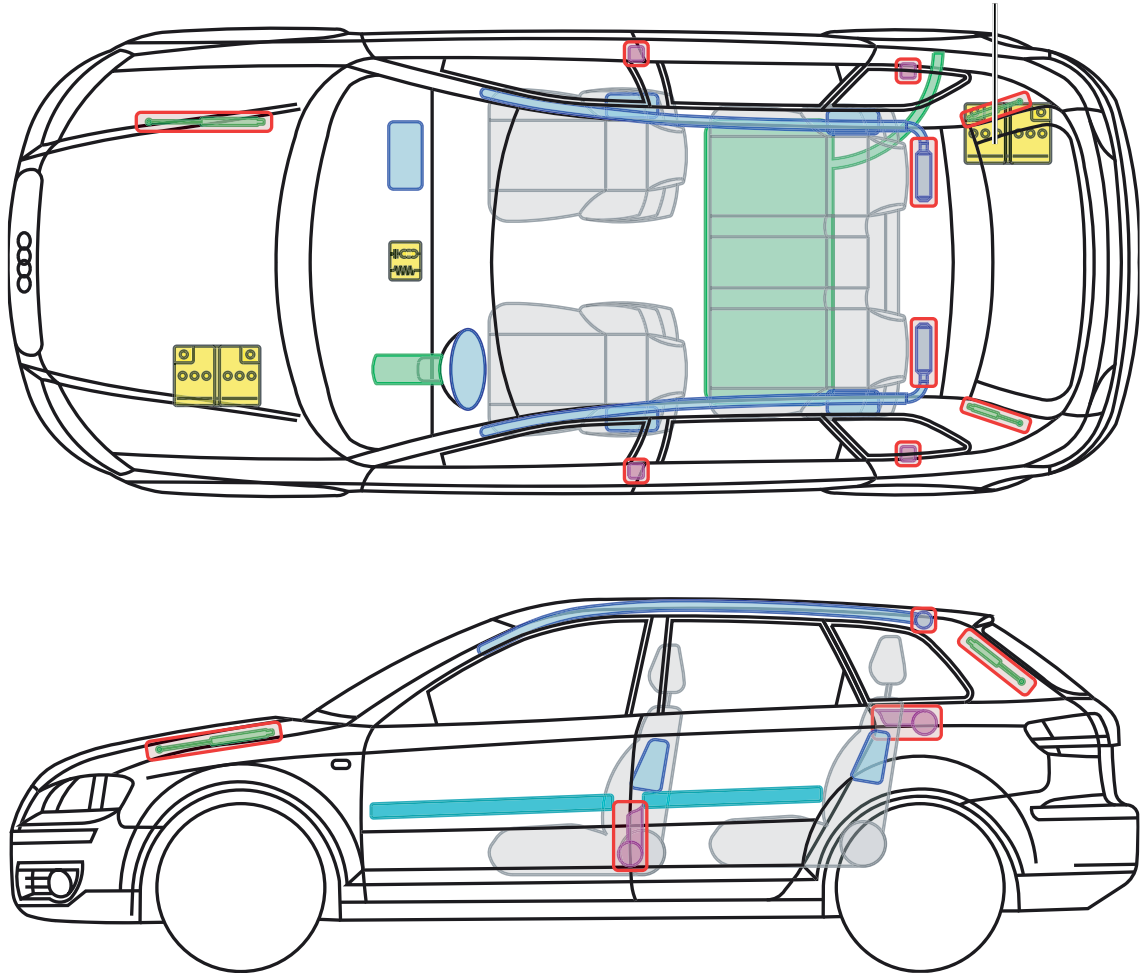

Audi A3 / S3 / RS3 Sportback

2004 – 2012

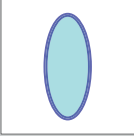
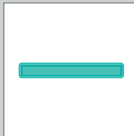
only V6 quattro + RS3

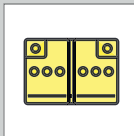
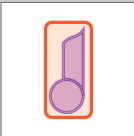

Legend

	Airbag		Reinforcement		Control module
	Gas generator		Rollover protection		Battery
	Pre-tensioner		Gas-pressure damper		Fuel tank

This document is a subject to the copyright of AUDI AG, Ingolstadt. Any duplication, distribution, storage, communication, broadcast and reproduction or transmission of the contents without written approval from AUDI AG is prohibited.





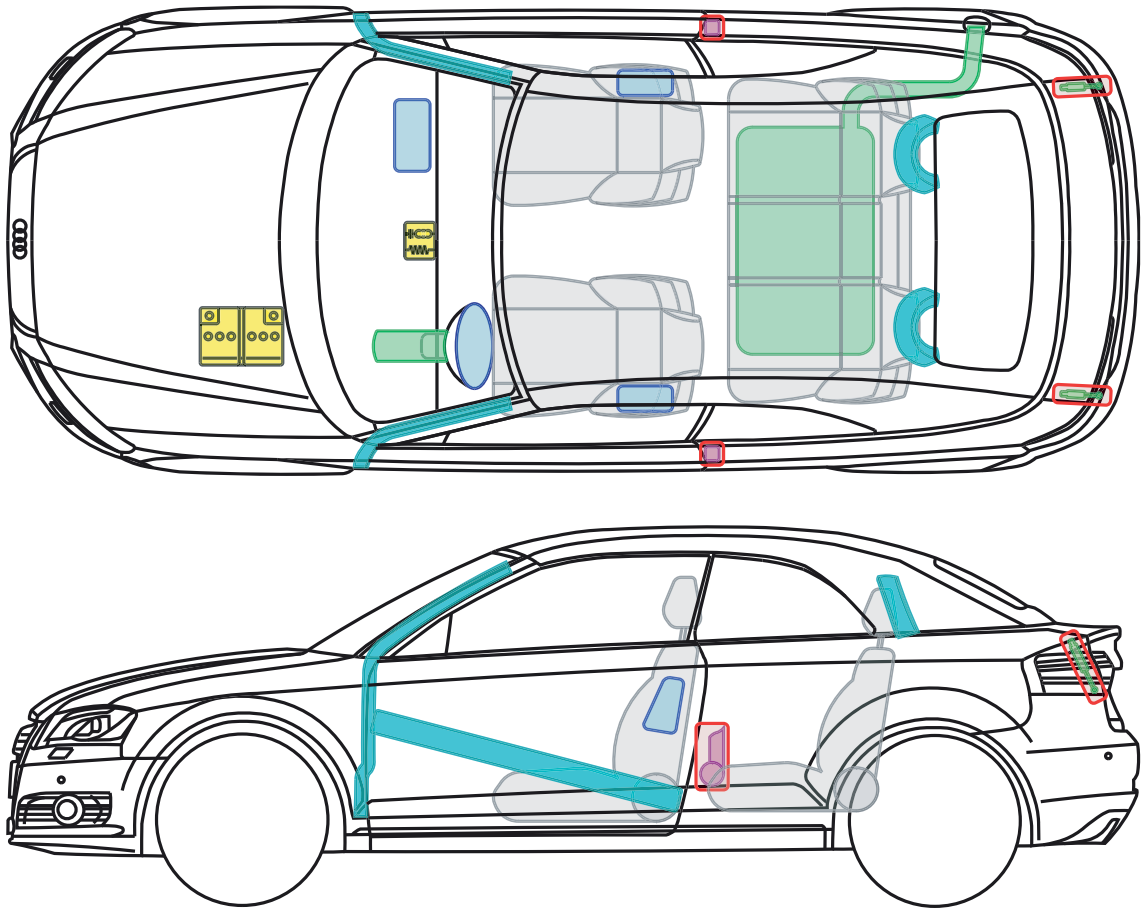

▶ Audi A3 Cabriolet

2008 – 2013

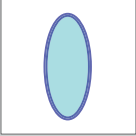
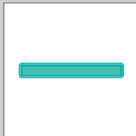
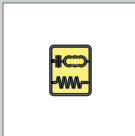
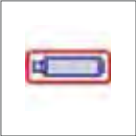

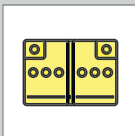
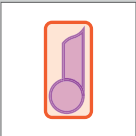
Legend

	Airbag		Reinforcement		Control module
	Gas generator		Rollover protection		Battery
	Pre-tensioner		Gas-pressure damper		Fuel tank

This document is a subject to the copyright of AUDI AG, Ingolstadt. Any duplication, distribution, storage, communication, broadcast and reproduction or transmission of the contents without written approval from AUDI AG is prohibited.







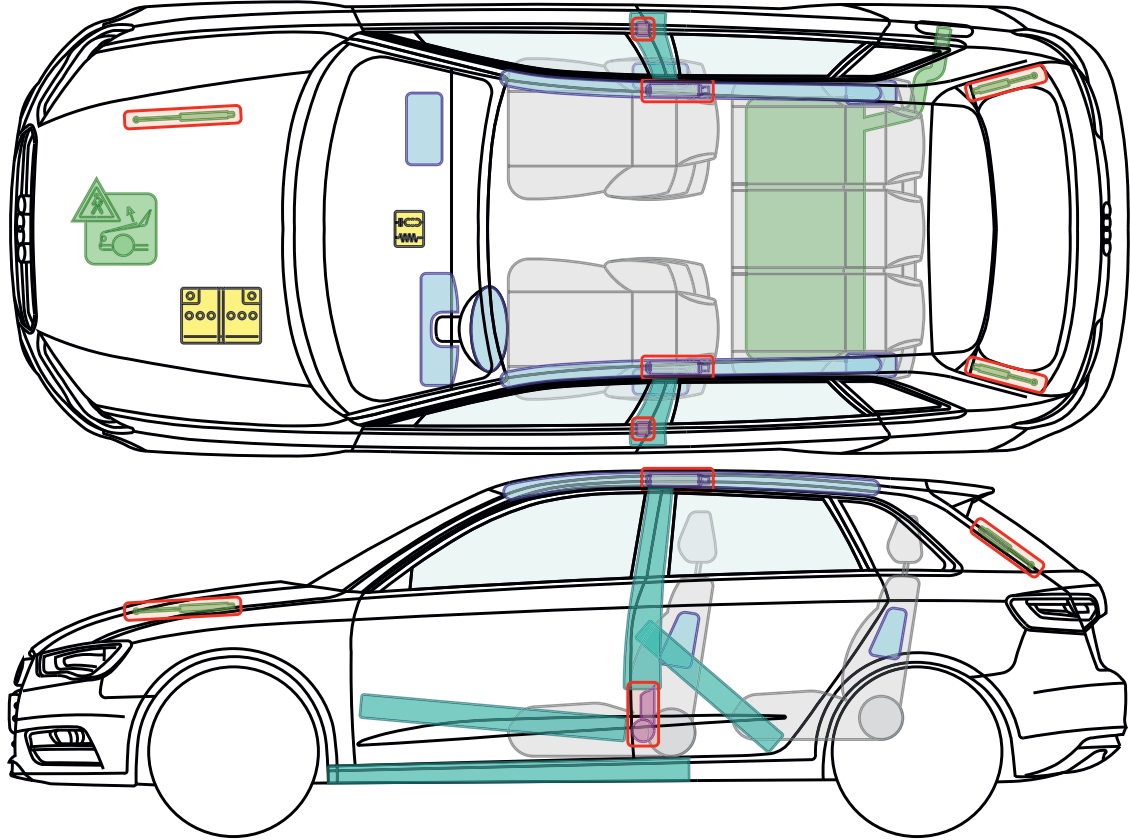

▶ Audi A3 / S3 Sportback

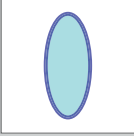
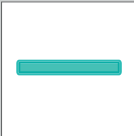
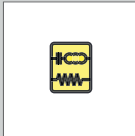
from 2012

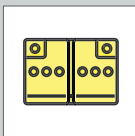
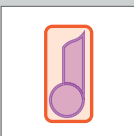

Legend

	Airbag		Reinforcement		Control module		Pedestrian protection system
	Gas generator		Overroll protection		12 V battery		
	Pretensioner		Gas-pressure damper		Fuel tank		

This document is a subject to the copyright of AUDI AG, Ingolstadt. Any duplication, distribution, storage, communication, broadcast and reproduction or transmission of the contents without written approval from AUDI AG is prohibited.



▶ Audi A3 Sportback e-tron

from 2014

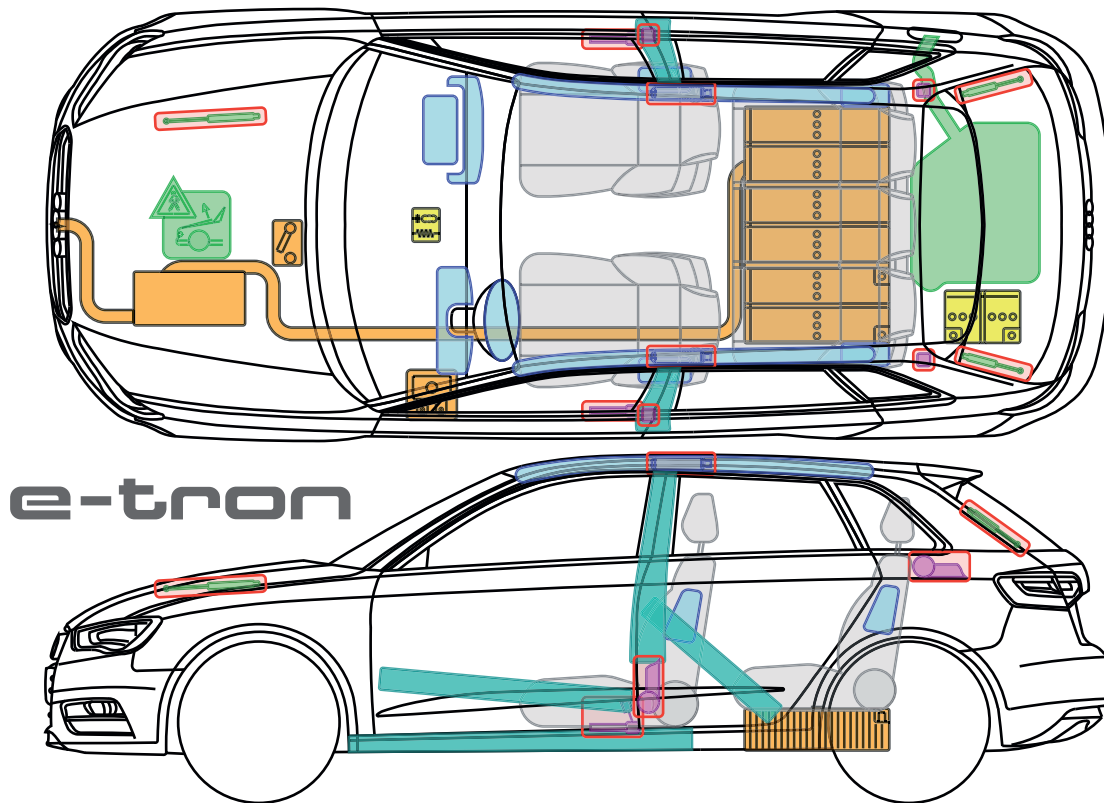

e-tron

Legend

	Airbag		Overroll protection		Fuel tank		High-voltage emergency disconnect
	Gas generator		Gas-pressure damper		High-voltage battery		Pedestrian protection system
	Pretensioner		Control module		High-voltage leads/components		
	Reinforcement		12 V battery		High-voltage emergency disconnect fuse		

This document is a subject to the copyright of AUDI AG, Ingolstadt. Any duplication, distribution, storage, communication, broadcast and reproduction or transmission of the contents without written approval from AUDI AG is prohibited.

Audi A3 Sportback e-tron

from 2014

Characteristic features

The A3 e-tron can be identified by the e-tron logo, the orange cables (e. g. in engine compartment) and the charging socket.



Vehicle immobilization

1. Gear lever in position park „P“
2. Apply parking brake



Switch off ignition

Press START-ENGINE-STOP button **without** depressing brake pedal.



Warning: When pressing the START-ENGINE-STOP button and depressing the brake pedal at the same time, the engine will start!

Audi A3 Sportback e-tron

from 2014

Deactivation of High Voltage System

Alternative 1 – Engine compartment accessible

1. Localize emergency disconnect
2. Open safety disconnect

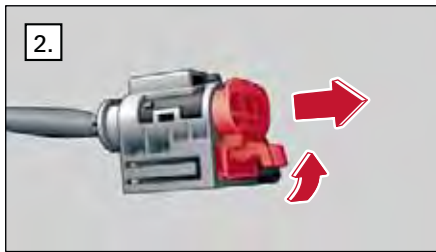
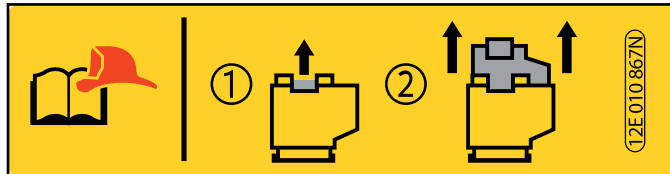
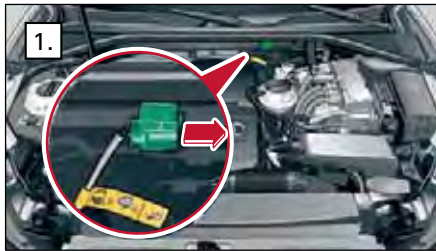

Alternative 2 – Emergency disconnect fuse in passenger compartment

1. Identify emergency fuse
2. Disconnect emergency fuse



Fuse box – **left-hand drive** (steering wheel left)

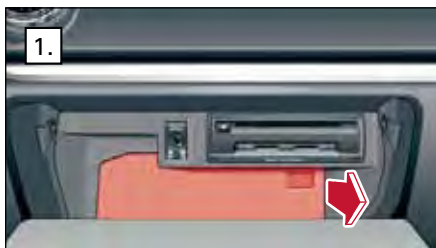

Fuse box in glove compartment **right-hand drive** (steering wheel right)

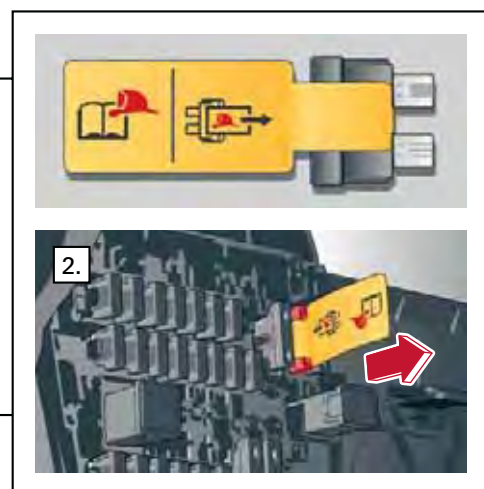

Audi A3 Sportback e-tron

from 2014

Disconnect 12 V battery

The 12 V battery is located in the luggage compartment below the luggage compartment floor. The cables of both terminals are fed out directly through the plastic cover.

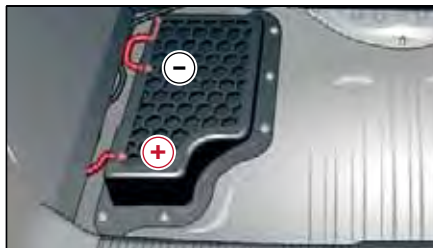

Disconnect charging cable

Vehicle connected to charging station:

1. Unlock vehicle via remote control or central locking switch
2. Disconnect charging cable

If required, follow further steps of this rescue data sheet





▶ Audi A3 / S3 Limousine

from 2013

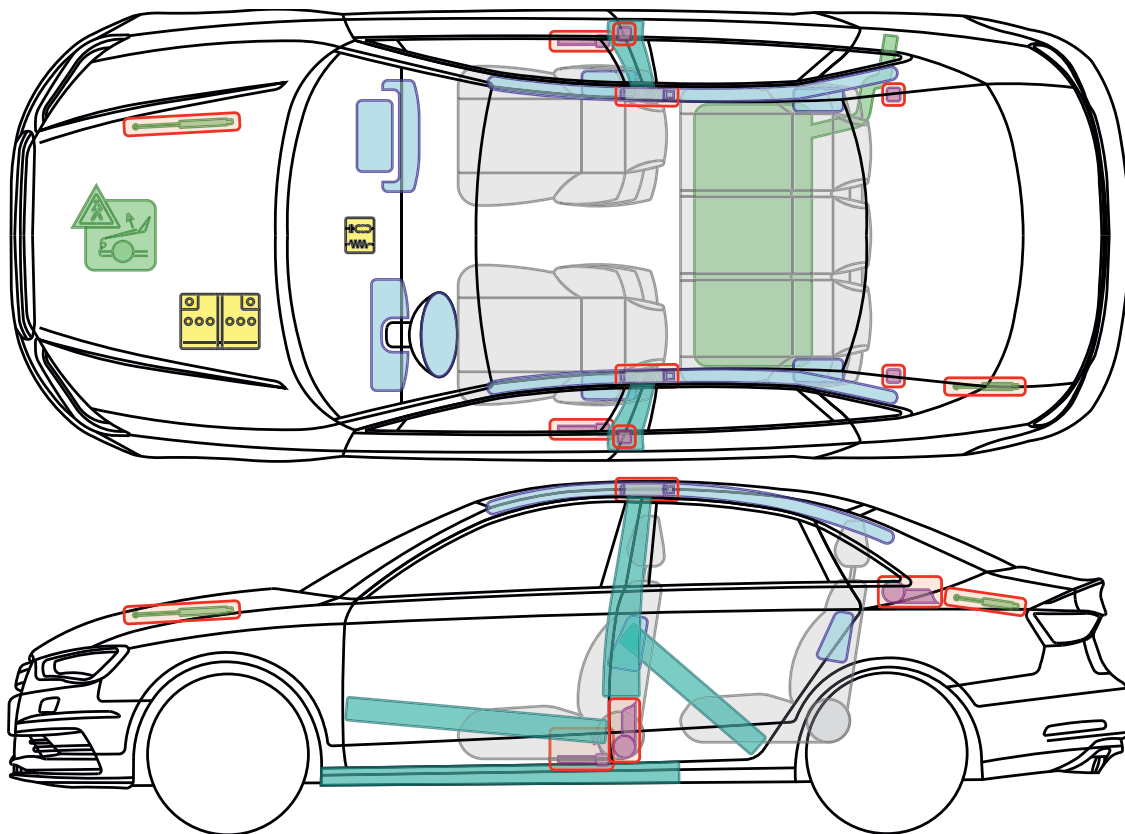

Legend

	Airbag		Reinforcement		Control module		Pedestrian protection system
	Gas generator		Overroll protection		12 V battery		
	Pretensioner		Gas-pressure damper		Fuel tank		



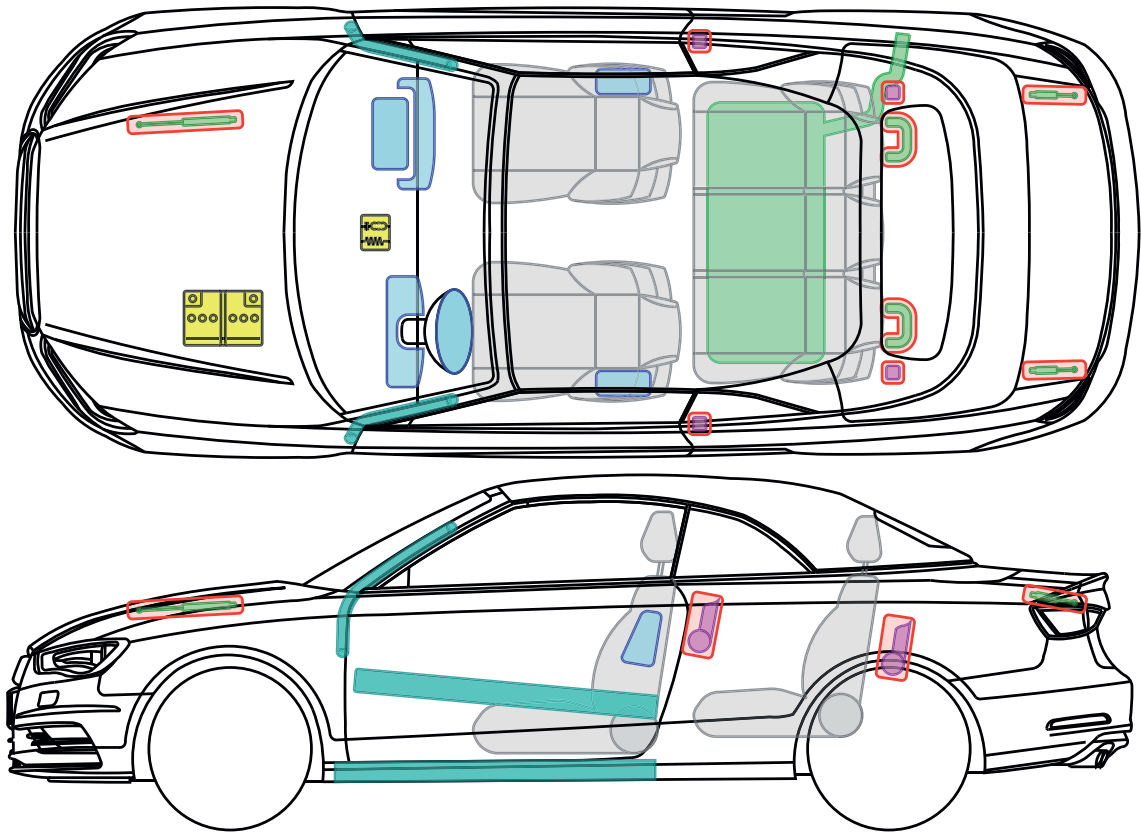

This document is a subject to the copyright of AUDI AG, Ingolstadt. Any duplication, distribution, storage, communication, broadcast and reproduction or transmission of the contents without written approval from AUDI AG is prohibited.

Audi A3 / S3 Cabriolet

from 2013

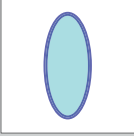
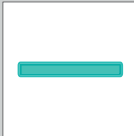
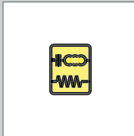

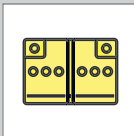
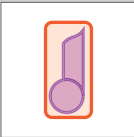
Legend

	Airbag		Reinforcement		Control module
	Gas generator		Rollover protection		Battery
	Pretensioner		Gas-pressure damper		Fuel tank

This document is a subject to the copyright of AUDI AG, Ingolstadt. Any duplication, distribution, storage, communication, broadcast and reproduction or transmission of the contents without written approval from AUDI AG is prohibited.



▶ Audi A4 / S4

1995 – 2001

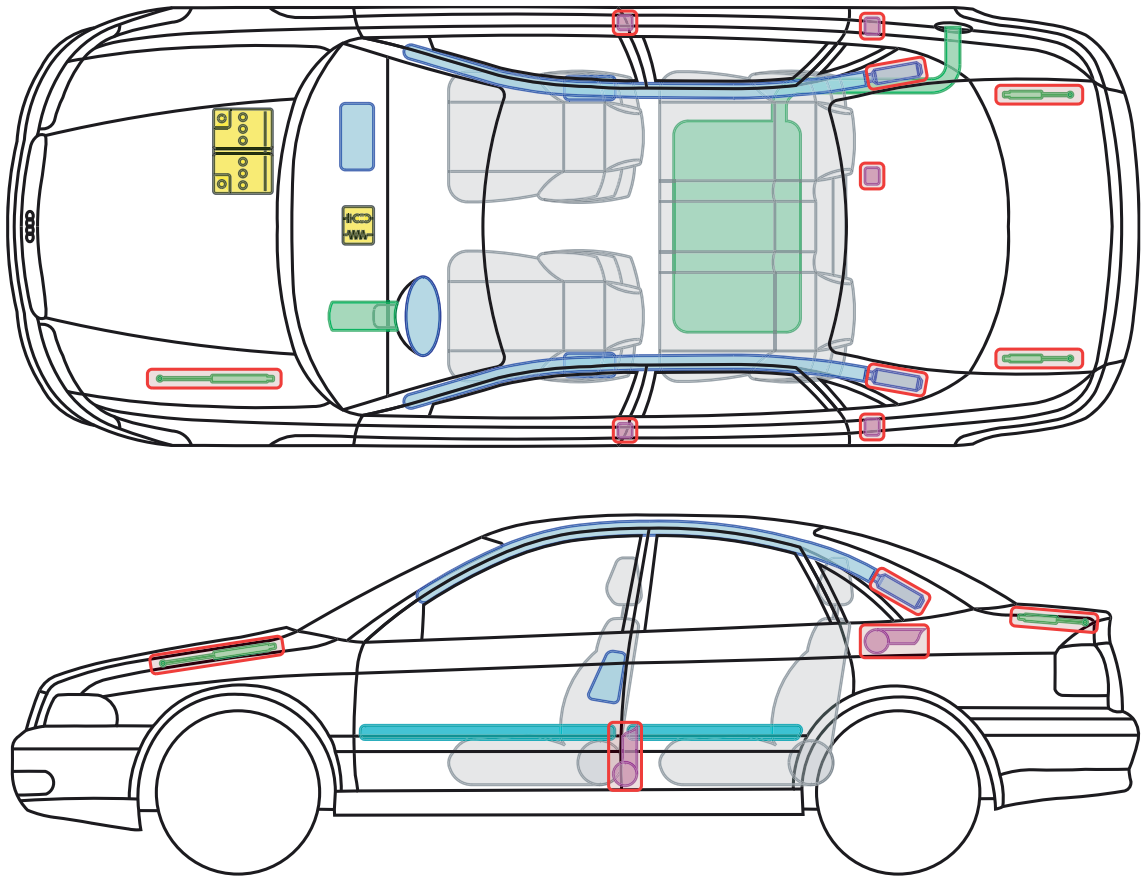

Legend

	Airbag		Reinforce-ment		Control module
	Gas generator		Rollover protection		Battery
	Pre-tensioner		Gas-pressure damper		Fuel tank

This document is a subject to the copyright of AUDI AG, Ingolstadt. Any duplication, distribution, storage, communication, broadcast and reproduction or transmission of the contents without written approval from AUDI AG is prohibited.







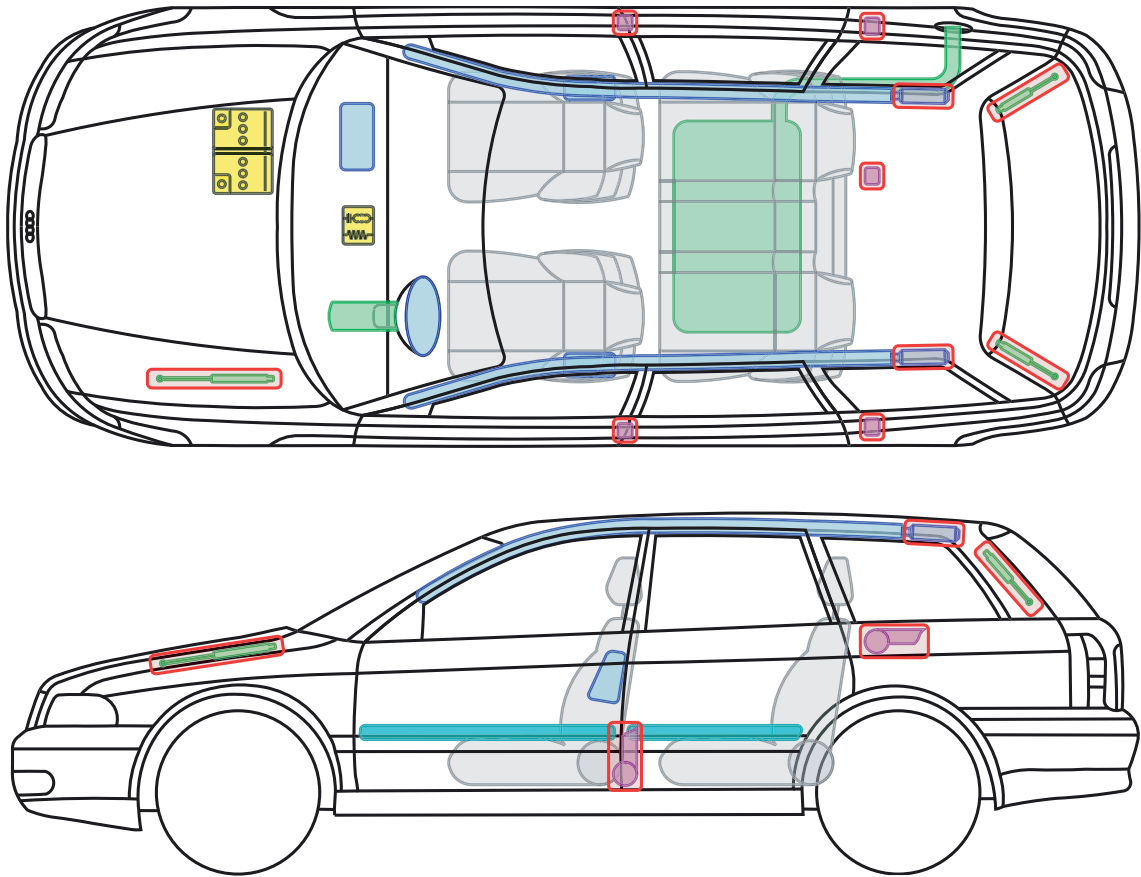

▶ Audi A4 / S4 / RS4 Avant

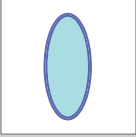
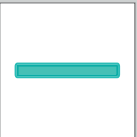
1996 – 2001

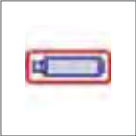

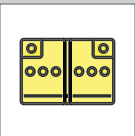
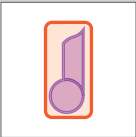
Legend

	Airbag		Reinforce-ment		Control module
	Gas generator		Rollover protection		Battery
	Pre-tensioner		Gas-pressure damper		Fuel tank

This document is a subject to the copyright of AUDI AG, Ingolstadt. Any duplication, distribution, storage, communication, broadcast and reproduction or transmission of the contents without written approval from AUDI AG is prohibited.



▶ Audi A4 / S4

2001 – 2005

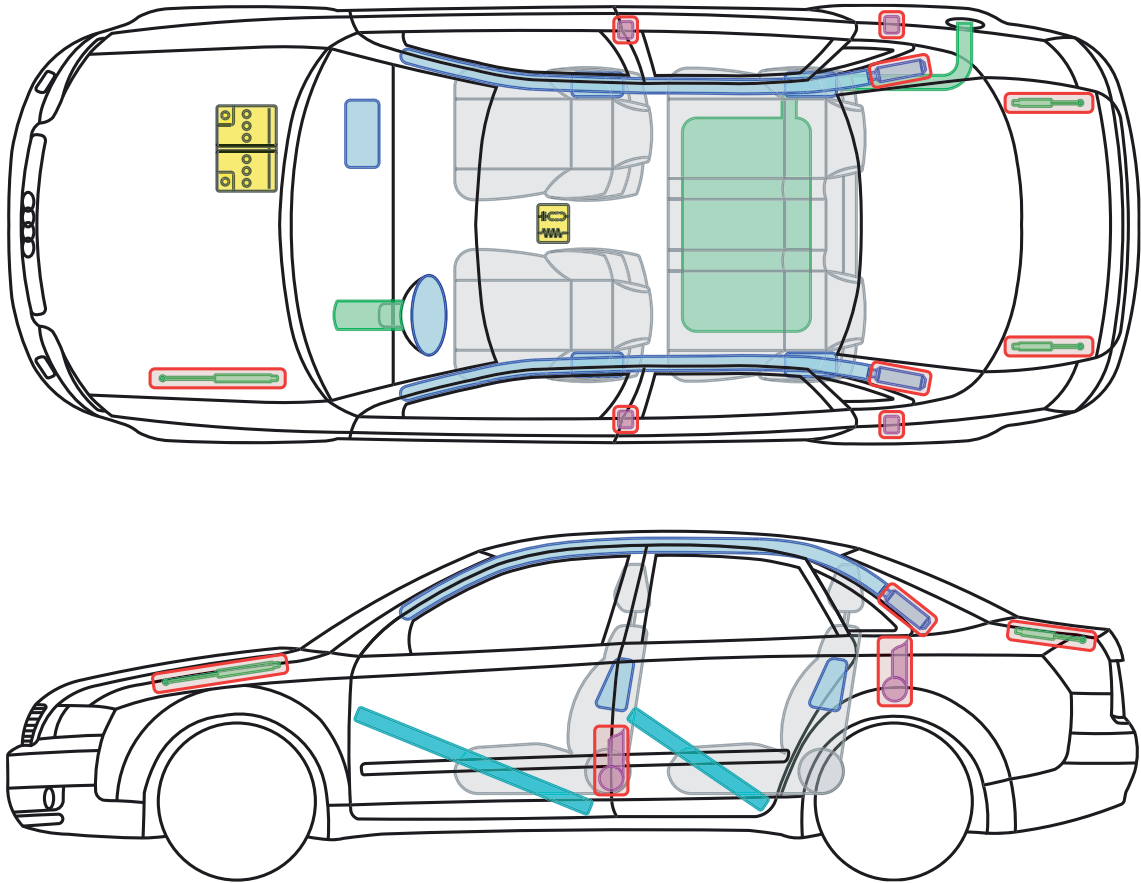

Legend

	Airbag		Reinforce-ment		Control module
	Gas generator		Rollover protection		Battery
	Pre-tensioner		Gas-pressure damper		Fuel tank

This document is a subject to the copyright of AUDI AG, Ingolstadt. Any duplication, distribution, storage, communication, broadcast and reproduction or transmission of the contents without written approval from AUDI AG is prohibited.







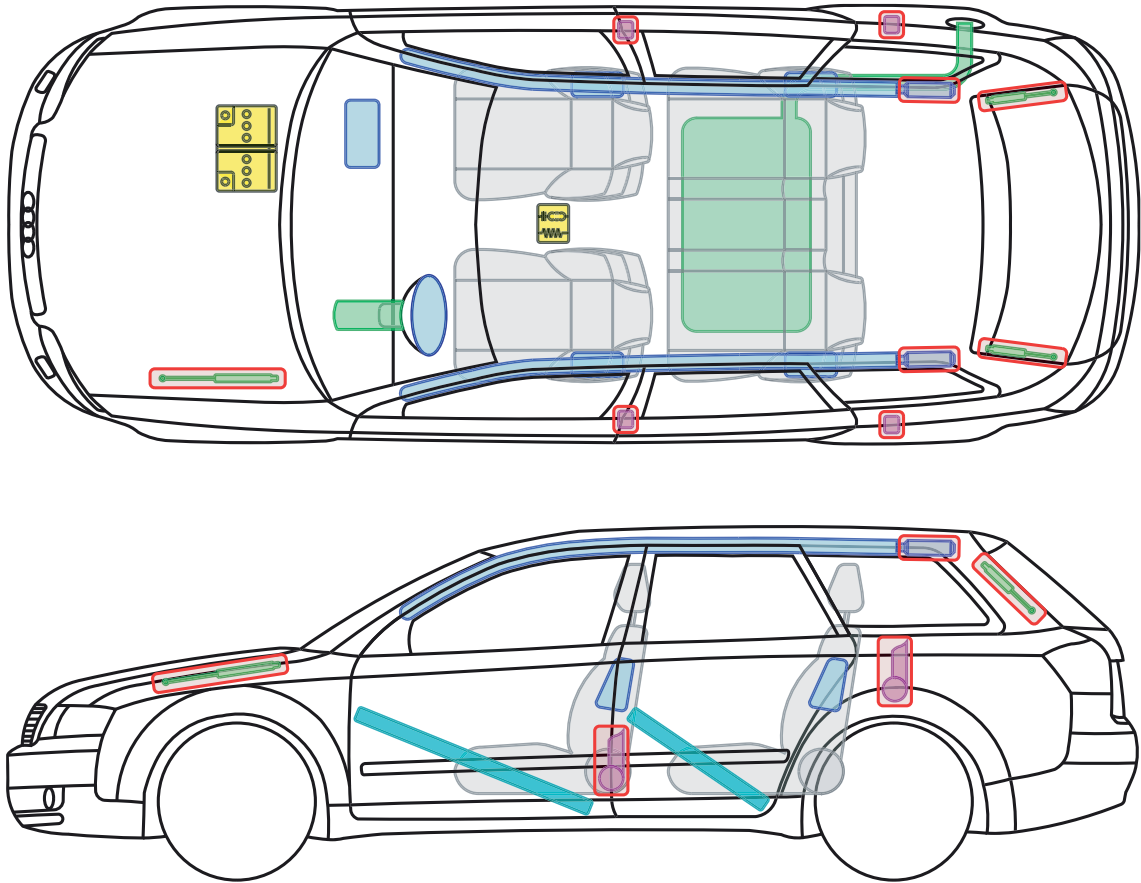

▶ Audi A4 / S4 Avant

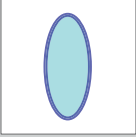
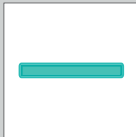
2001 – 2005

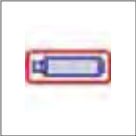

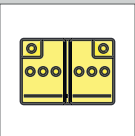
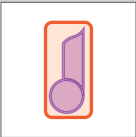
Legend

	Airbag		Reinforcement		Control module
	Gas generator		Rollover protection		Battery
	Pre-tensioner		Gas-pressure damper		Fuel tank

This document is a subject to the copyright of AUDI AG, Ingolstadt. Any duplication, distribution, storage, communication, broadcast and reproduction or transmission of the contents without written approval from AUDI AG is prohibited.







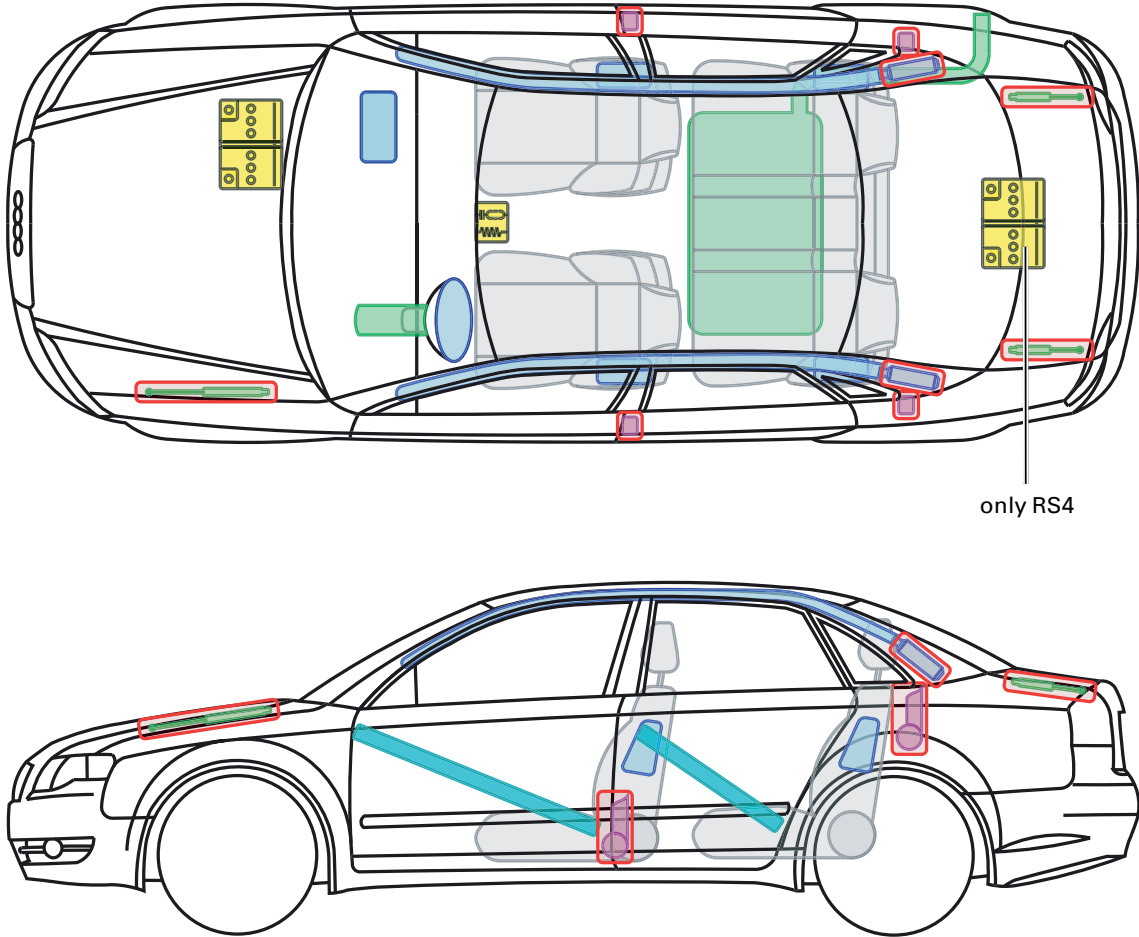

▶ Audi A4 / S4 / RS4

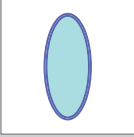
2005 – 2007

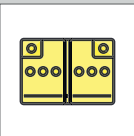
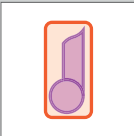

Legend

	Airbag		Reinforcement		Control module
	Gas generator		Rollover protection		Battery
	Pre-tensioner		Gas-pressure damper		Fuel tank

This document is a subject to the copyright of AUDI AG, Ingolstadt. Any duplication, distribution, storage, communication, broadcast and reproduction or transmission of the contents without written approval from AUDI AG is prohibited.







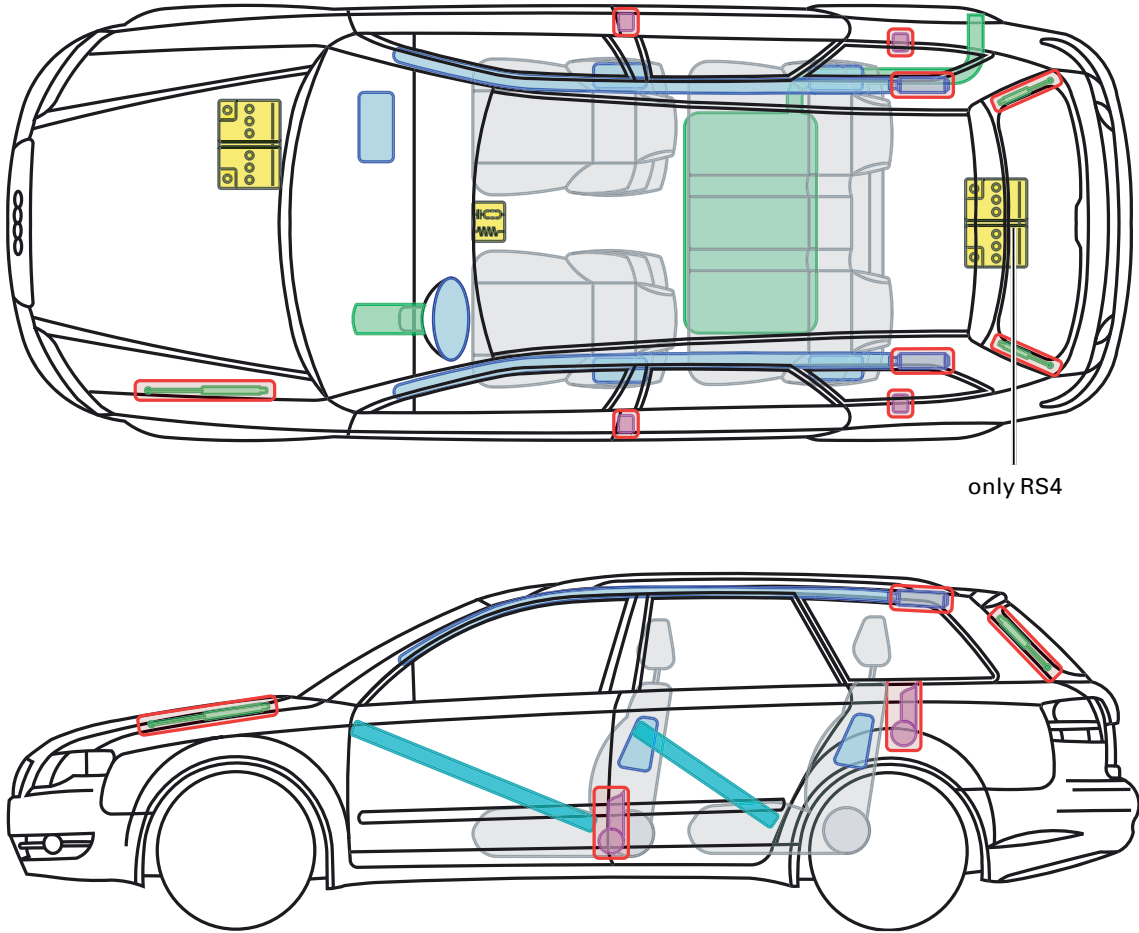

▶ Audi A4 / S4 / RS4 Avant

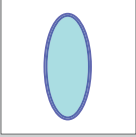
2005 – 2008

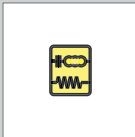
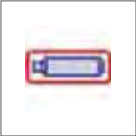

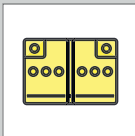
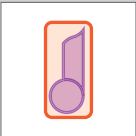
Legend

	Airbag		Reinforce-ment		Control module
	Gas generator		Rollover protection		Battery
	Pre-tensioner		Gas-pressure damper		Fuel tank

This document is a subject to the copyright of AUDI AG, Ingolstadt. Any duplication, distribution, storage, communication, broadcast and reproduction or transmission of the contents without written approval from AUDI AG is prohibited.





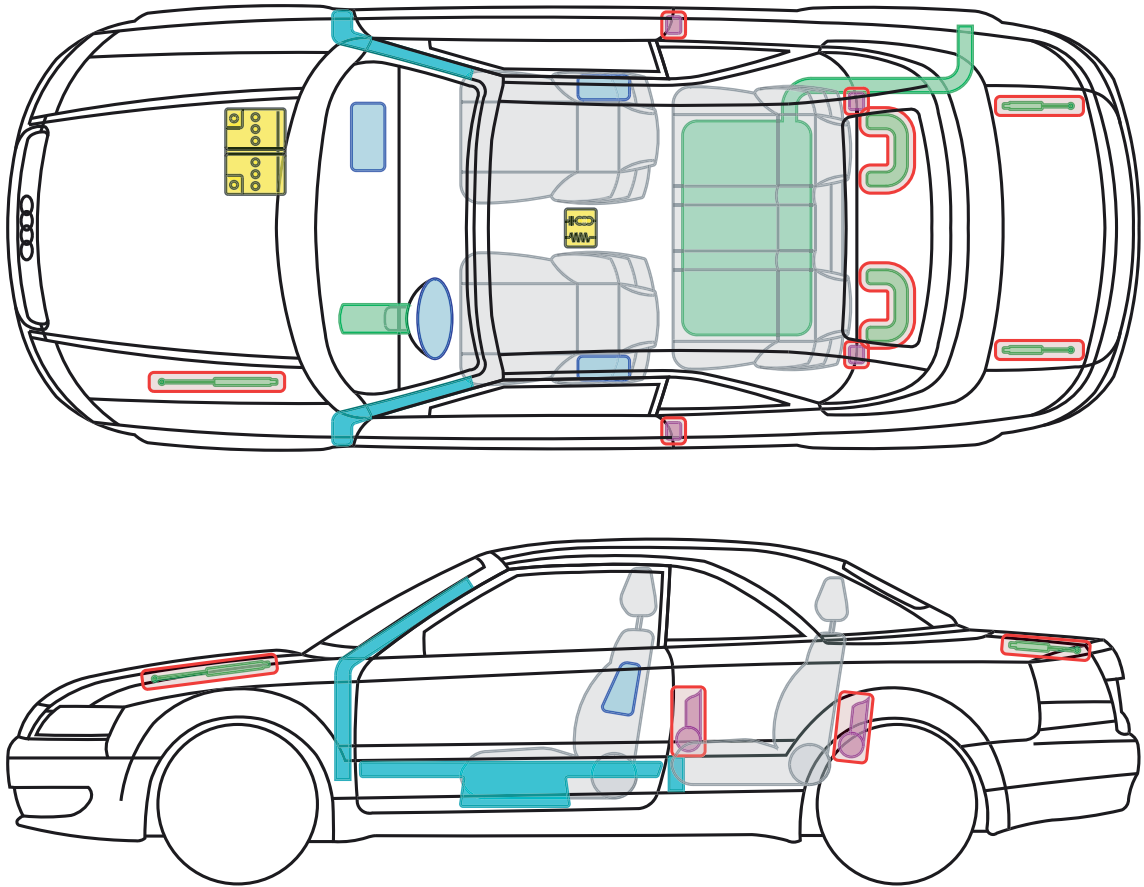

▶ Audi A4 / S4 Cabriolet

2002 – 2005

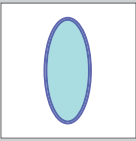
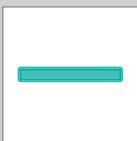
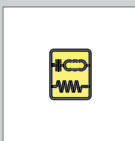
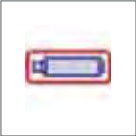

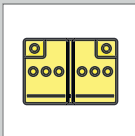
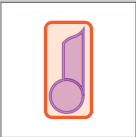
Legend

	Airbag		Reinforcement		Control module
	Gas generator		Rollover protection		Battery
	Pre-tensioner		Gas-pressure damper		Fuel tank

This document is a subject to the copyright of AUDI AG, Ingolstadt. Any duplication, distribution, storage, communication, broadcast and reproduction or transmission of the contents without written approval from AUDI AG is prohibited.







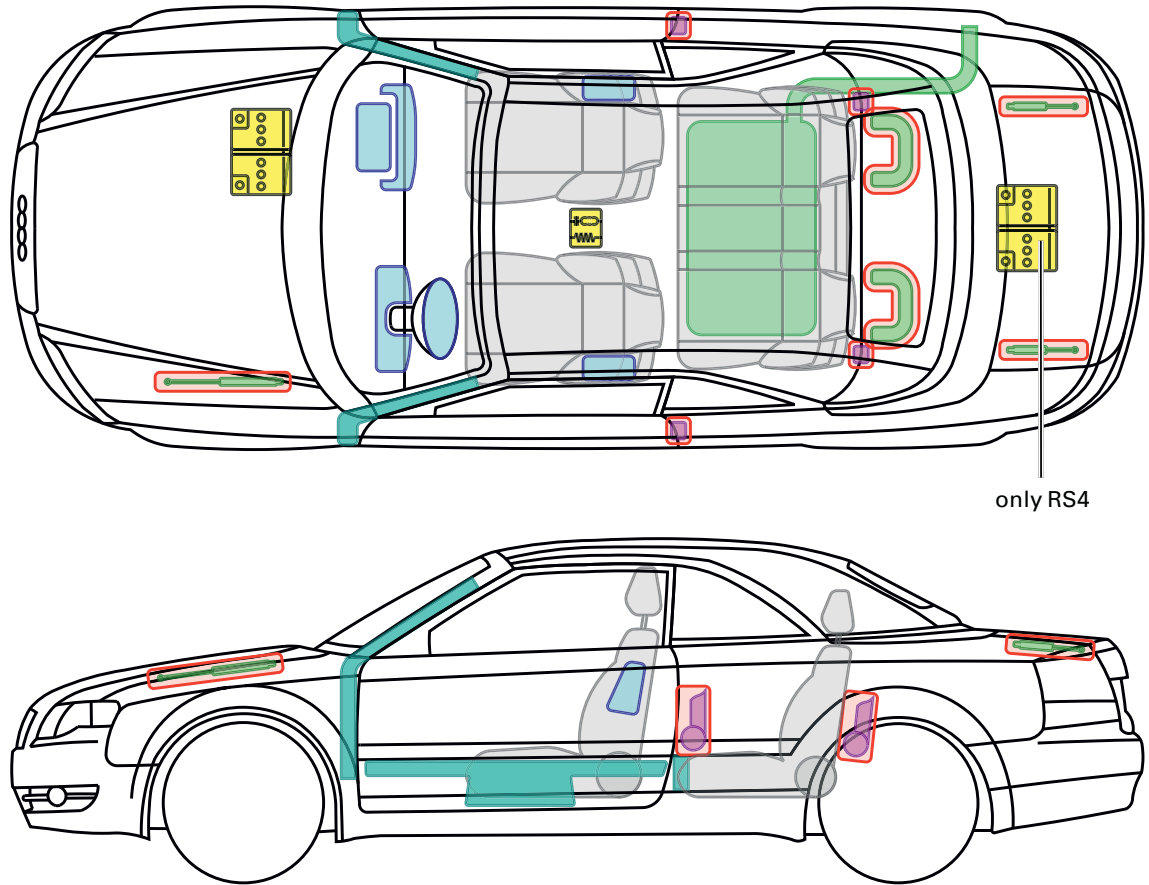

▶ Audi A4 / S4 / RS4 Cabriolet

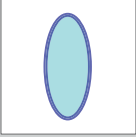
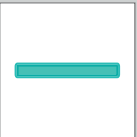
2005 – 2009

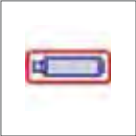

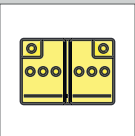
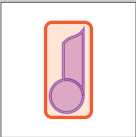
Legend

	Airbag		Reinforcement		Control module
	Gas generator		Rollover protection		Battery
	Pre-tensioner		Gas-pressure damper		Fuel tank

This document is a subject to the copyright of AUDI AG, Ingolstadt. Any duplication, distribution, storage, communication, broadcast and reproduction or transmission of the contents without written approval from AUDI AG is prohibited.



▶ Audi A4 / S4

2007 – 2012

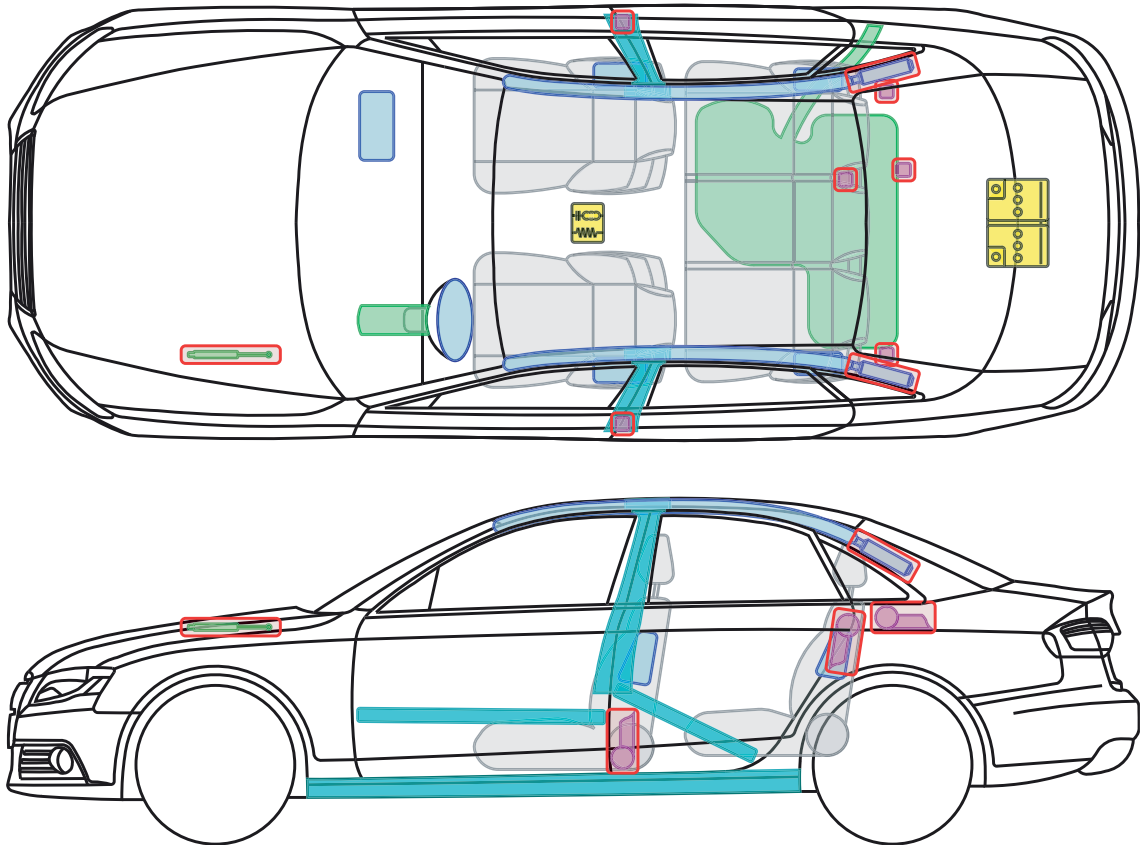

Legend

	Airbag		Reinforce-ment		Control module
	Gas generator		Rollover protection		Battery
	Pre-tensioner		Gas-pressure damper		Fuel tank

This document is a subject to the copyright of AUDI AG, Ingolstadt. Any duplication, distribution, storage, communication, broadcast and reproduction or transmission of the contents without written approval from AUDI AG is prohibited.







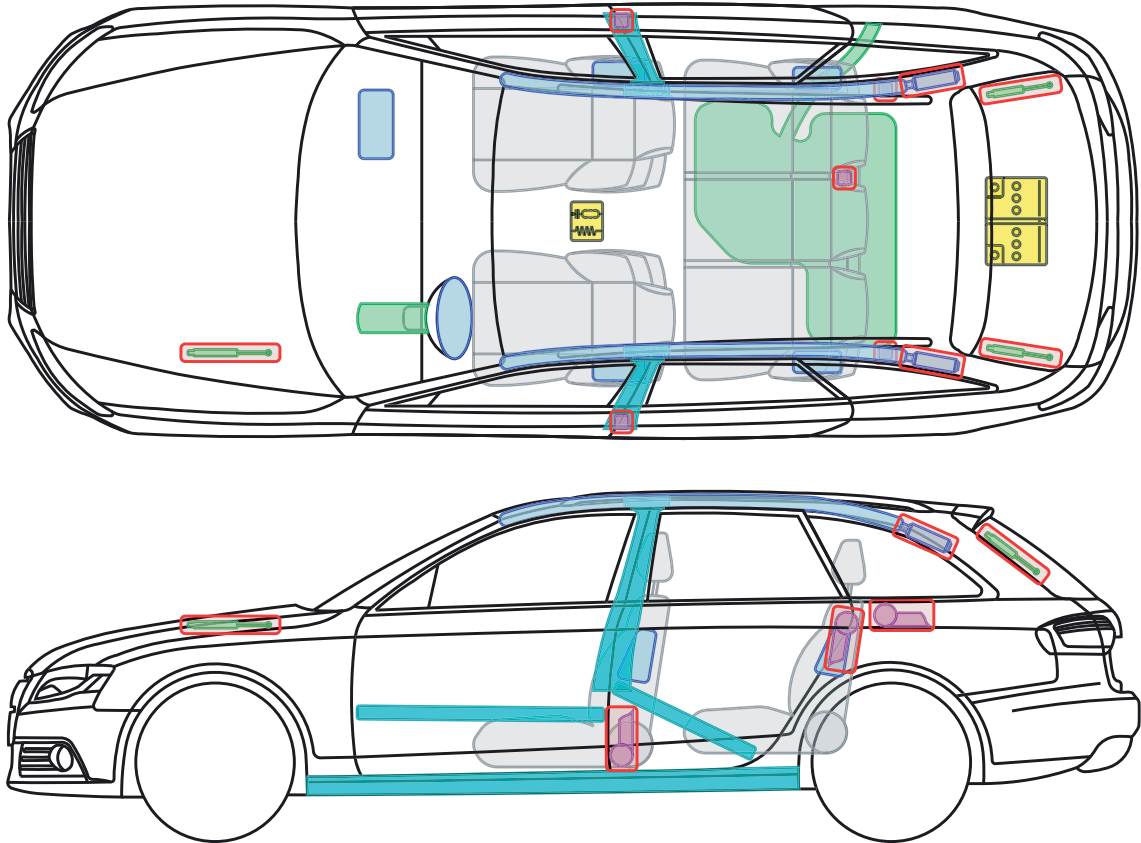

▶ Audi A4 /S4 Avant

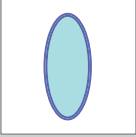
2008 – 2012

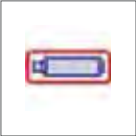

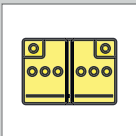
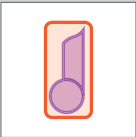
Legend

	Airbag		Reinforcement		Control module
	Gas generator		Rollover protection		Battery
	Pre-tensioner		Gas-pressure damper		Fuel tank

This document is a subject to the copyright of AUDI AG, Ingolstadt. Any duplication, distribution, storage, communication, broadcast and reproduction or transmission of the contents without written approval from AUDI AG is prohibited.







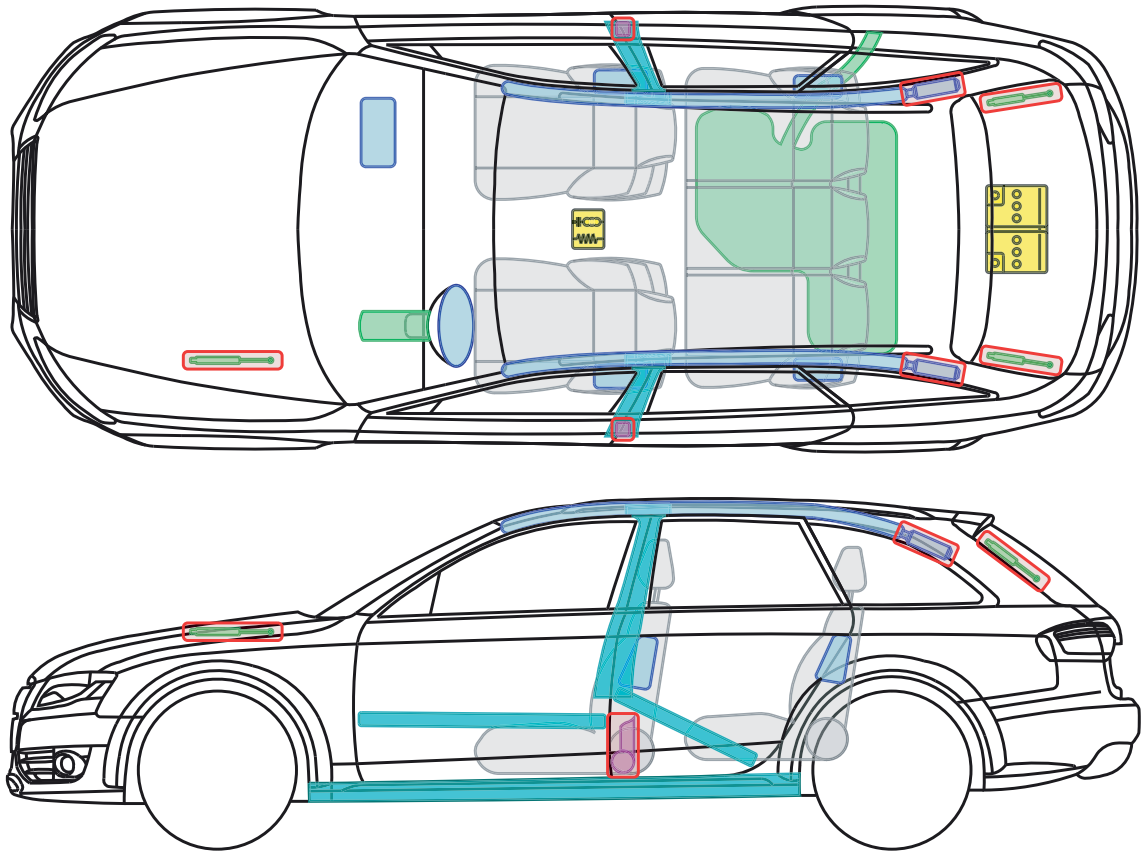

▶ Audi A4 allroad

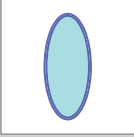
2009 – 2012

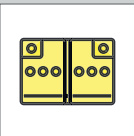
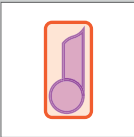

Legend

	Airbag		Reinforcement		Control module
	Gas generator		Rollover protection		Battery
	Pre-tensioner		Gas-pressure damper		Fuel tank

This document is a subject to the copyright of AUDI AG, Ingolstadt. Any duplication, distribution, storage, communication, broadcast and reproduction or transmission of the contents without written approval from AUDI AG is prohibited.





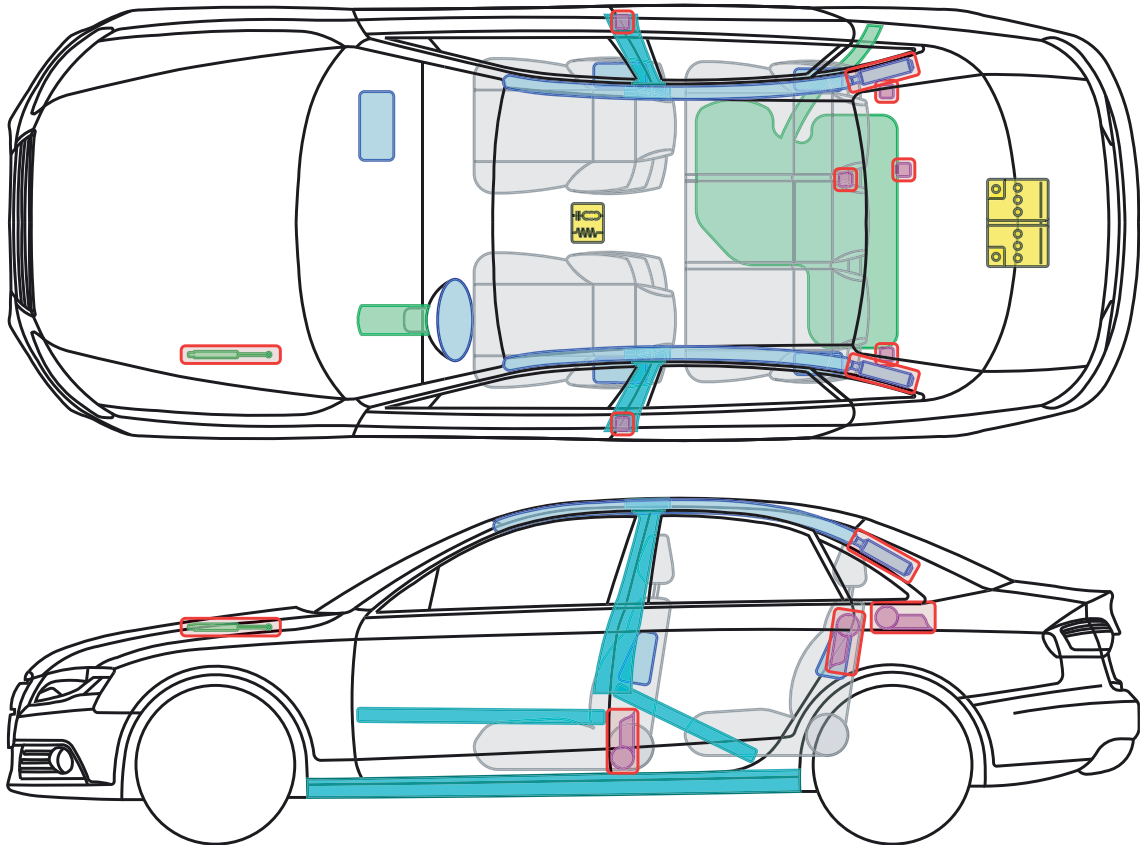

▶ Audi A4 / S4

from 2012

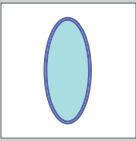
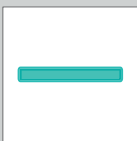
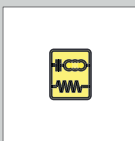
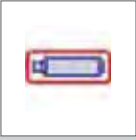

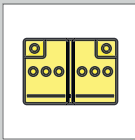
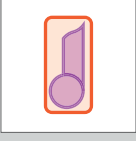
Legend

	Airbag		Reinforcement		Control module
	Gas generator		Rollover protection		Battery
	Pretensioner		Gas-pressure damper		Fuel tank

This document is a subject to the copyright of AUDI AG, Ingolstadt. Any duplication, distribution, storage, communication, broadcast and reproduction or transmission of the contents without written approval from AUDI AG is prohibited.







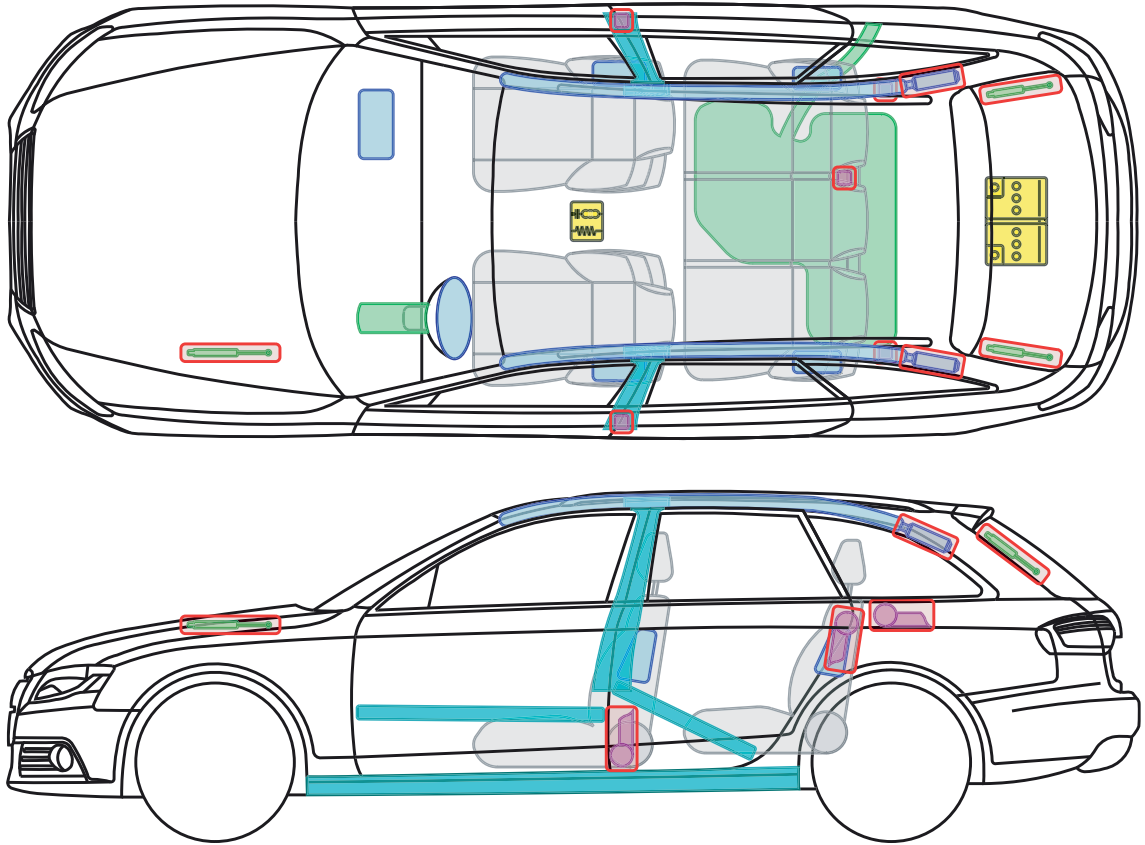

▶ Audi A4 / S4 / RS4 Avant

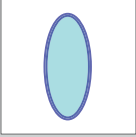
from 2012

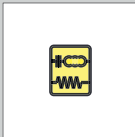
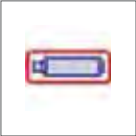

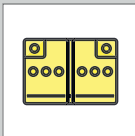
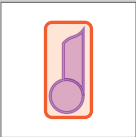
Legend

	Airbag		Reinforcement		Control module
	Gas generator		Rollover protection		Battery
	Pre-tensioner		Gas-pressure damper		Fuel tank

This document is a subject to the copyright of AUDI AG, Ingolstadt. Any duplication, distribution, storage, communication, broadcast and reproduction or transmission of the contents without written approval from AUDI AG is prohibited.







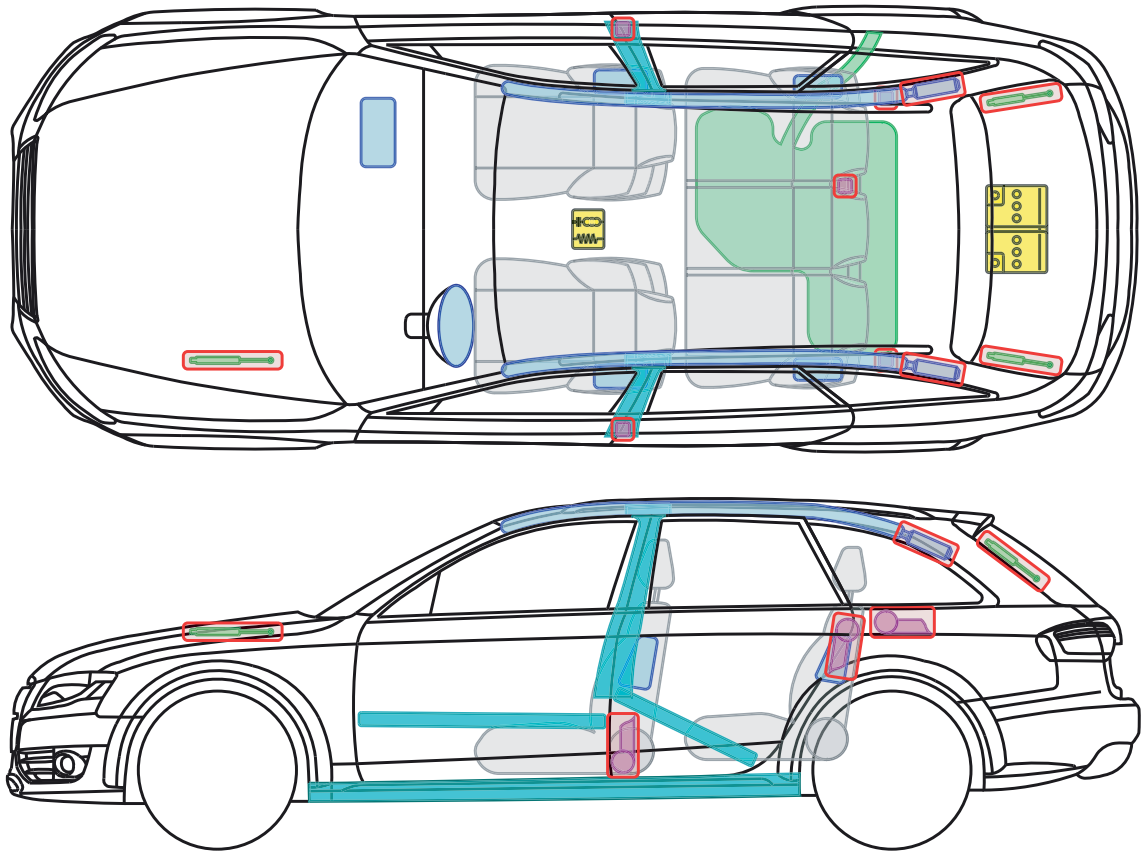

▶ Audi A4 allroad

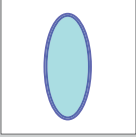
from 2012

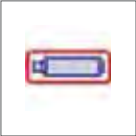

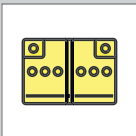
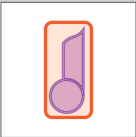
Legend

	Airbag		Reinforcement		Control module
	Gas generator		Rollover protection		Battery
	Pre-tensioner		Gas-pressure damper		Fuel tank

This document is a subject to the copyright of AUDI AG, Ingolstadt. Any duplication, distribution, storage, communication, broadcast and reproduction or transmission of the contents without written approval from AUDI AG is prohibited.



▶ Audi A5 / S5 / RS5

2007 – 2011

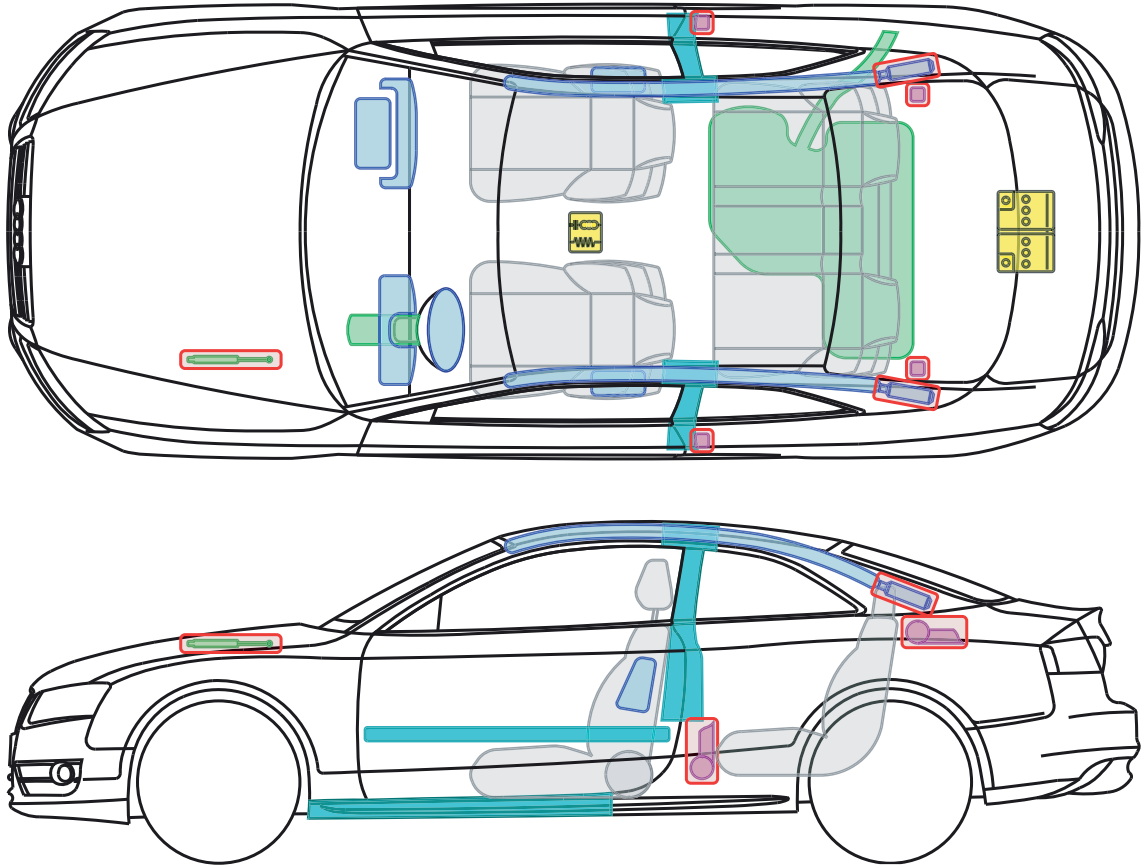

Legend

	Airbag		Reinforcement		Control module
	Gas generator		Rollover protection		Battery
	Pre-tensioner		Gas-pressure damper		Fuel tank

This document is a subject to the copyright of AUDI AG, Ingolstadt. Any duplication, distribution, storage, communication, broadcast and reproduction or transmission of the contents without written approval from AUDI AG is prohibited.







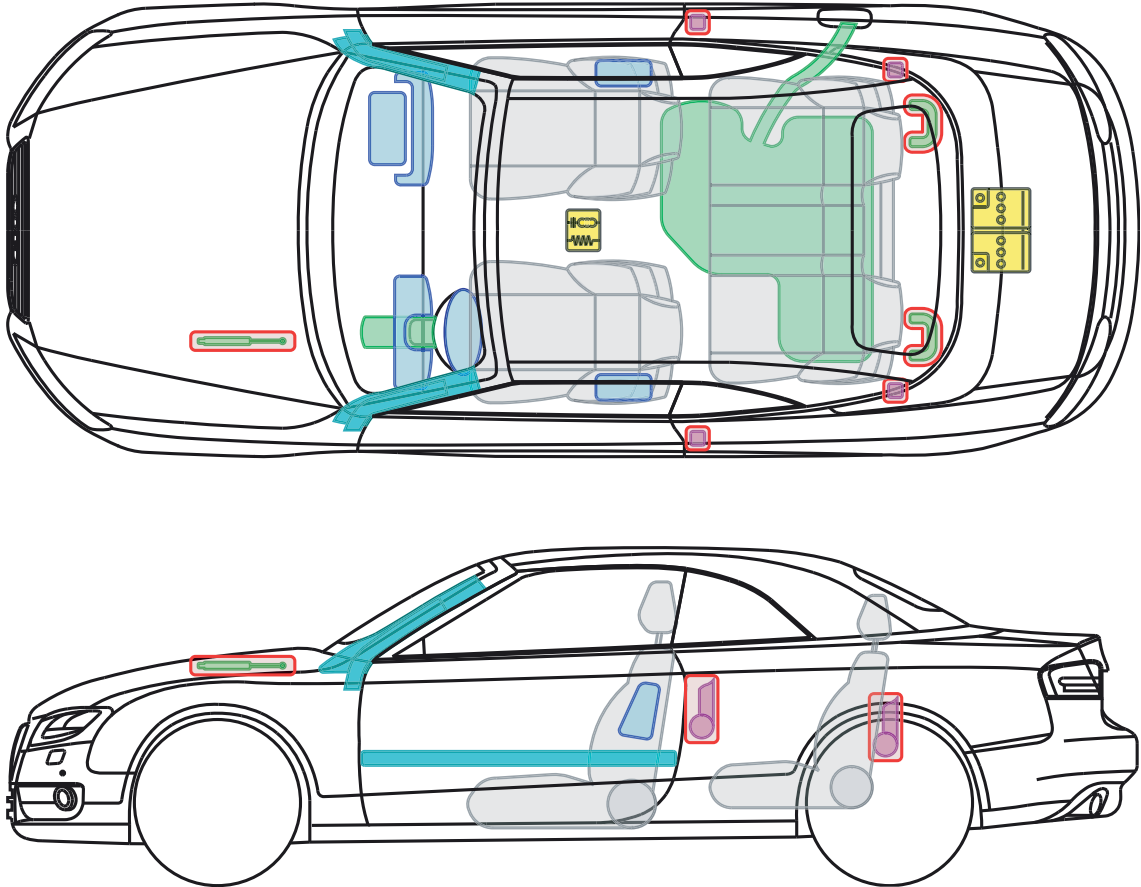

▶ Audi A5 / S5 Cabriolet

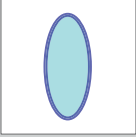
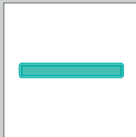
2009 – 2011

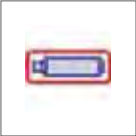

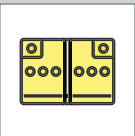
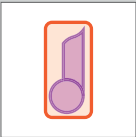
Legend

	Airbag		Reinforcement		Control module
	Gas generator		Rollover protection		Battery
	Pretensioner		Gas-pressure damper		Fuel tank

This document is a subject to the copyright of AUDI AG, Ingolstadt. Any duplication, distribution, storage, communication, broadcast and reproduction or transmission of the contents without written approval from AUDI AG is prohibited.







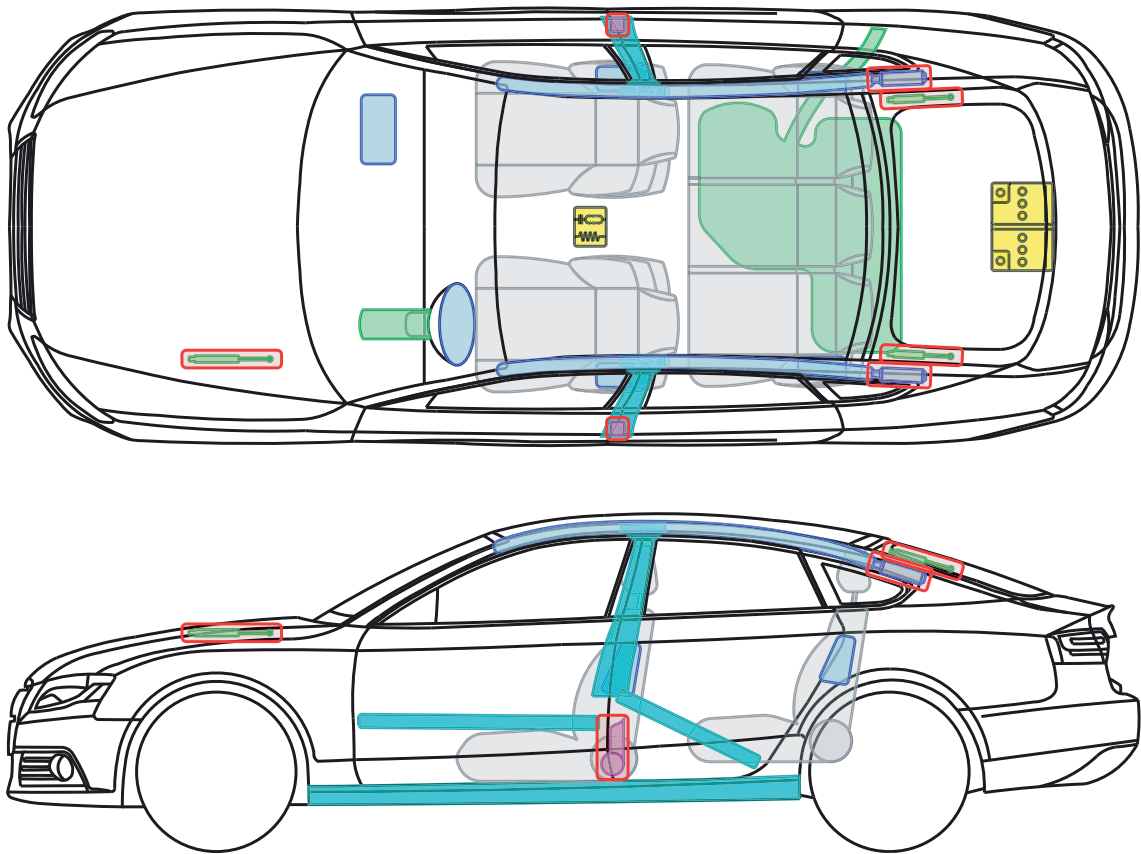

▶ Audi A5 / S5 Sportback

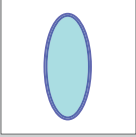
2009 – 2011

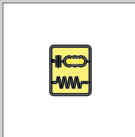
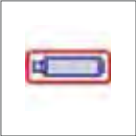

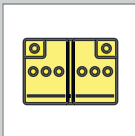
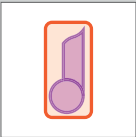
Legend

	Airbag		Reinforce-ment		Control module
	Gas generator		Rollover protection		Battery
	Pre-tensioner		Gas-pressure damper		Fuel tank

This document is a subject to the copyright of AUDI AG, Ingolstadt. Any duplication, distribution, storage, communication, broadcast and reproduction or transmission of the contents without written approval from AUDI AG is prohibited.





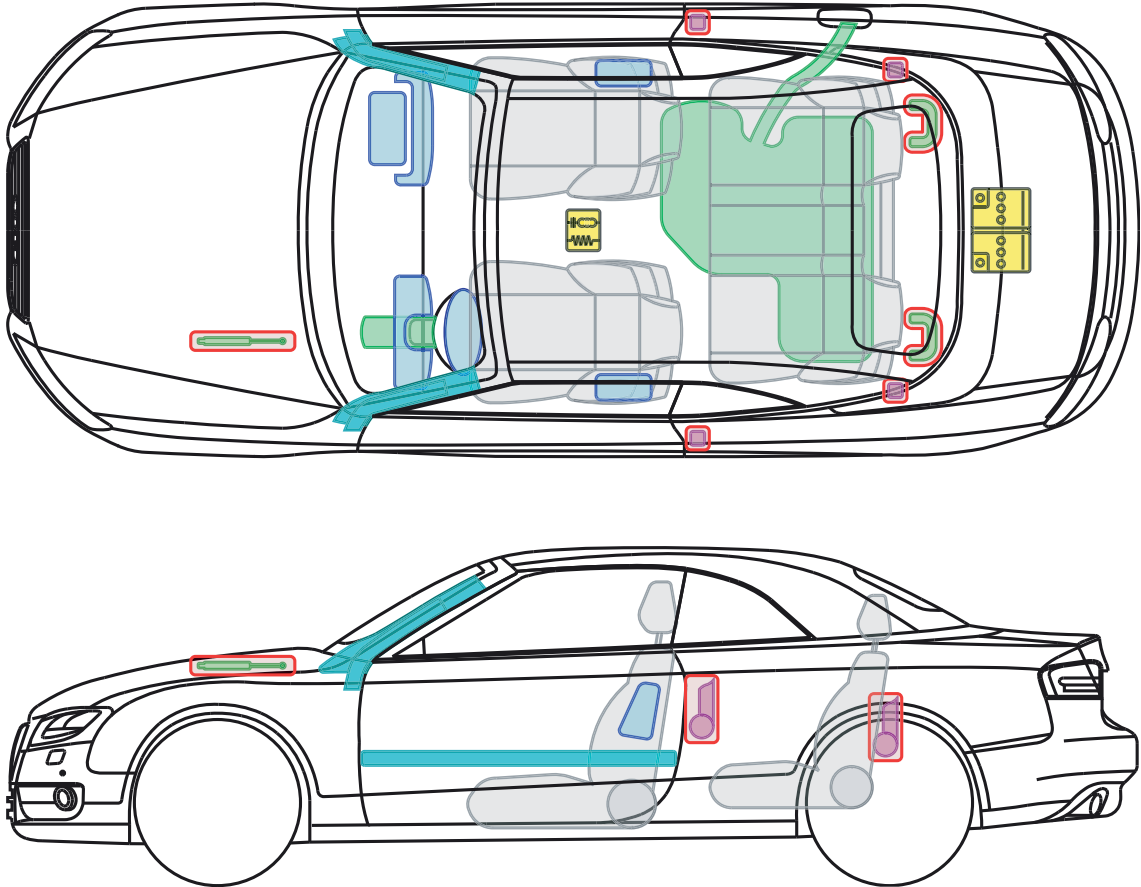

▶ Audi A5 / S5 / RS5 Cabriolet

from 2011

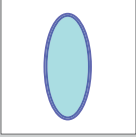
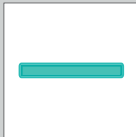
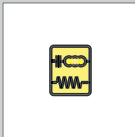
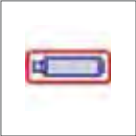

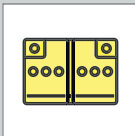
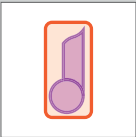
Legend

	Airbag		Reinforcement		Control module
	Gas generator		Rollover protection		Battery
	Pretensioner		Gas-pressure damper		Fuel tank

This document is a subject to the copyright of AUDI AG, Ingolstadt. Any duplication, distribution, storage, communication, broadcast and reproduction or transmission of the contents without written approval from AUDI AG is prohibited.







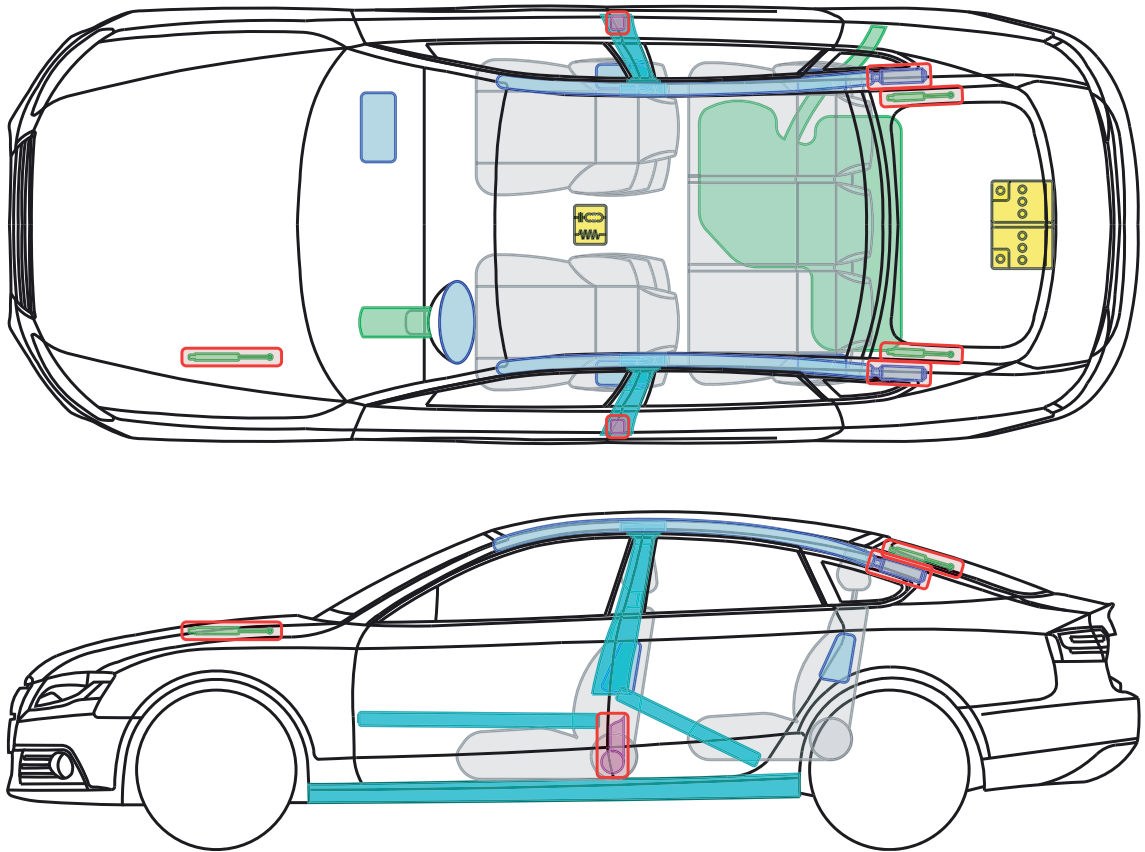

▶ Audi A5 / S5 Sportback

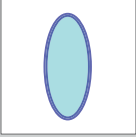
from 2011

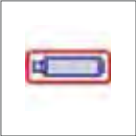

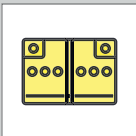
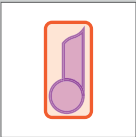
Legend

	Airbag		Reinforce-ment		Control module
	Gas generator		Rollover protection		Battery
	Pre-tensioner		Gas-pressure damper		Fuel tank

This document is a subject to the copyright of AUDI AG, Ingolstadt. Any duplication, distribution, storage, communication, broadcast and reproduction or transmission of the contents without written approval from AUDI AG is prohibited.